

Mod. FE

Low-pressure gas regulator



TECHNICAL BROCHURE

Pietro Fiorentini S.p.A.

Via E.Fermi, 8/10 | 36057 Arcugnano, Italy | +39 0444 968 511
sales@fiorentini.com

The data contained in this document are not binding.
Pietro Fiorentini reserves the right to make changes without prior notice.

modfe_technicalbrochure_ENG_revA

www.fiorentini.com

Who we are

We are an international company specialising in the design and manufacture of cutting-edge devices and solutions for natural gas processing, transport and distribution systems. We are the ideal partner for operators in the Oil & Gas sector, with a business offer that goes across the whole natural gas chain.

We are in constant evolution to meet our customers' highest expectations in terms of quality and reliability.

Our aim is to be a step ahead of the competition, with customized technologies and an after-sale service program undertaken with the highest grade of professionalism.



Pietro Fiorentini advantages



Localised technical support



Experience since 1940



We operate in over 100 countries

Application area

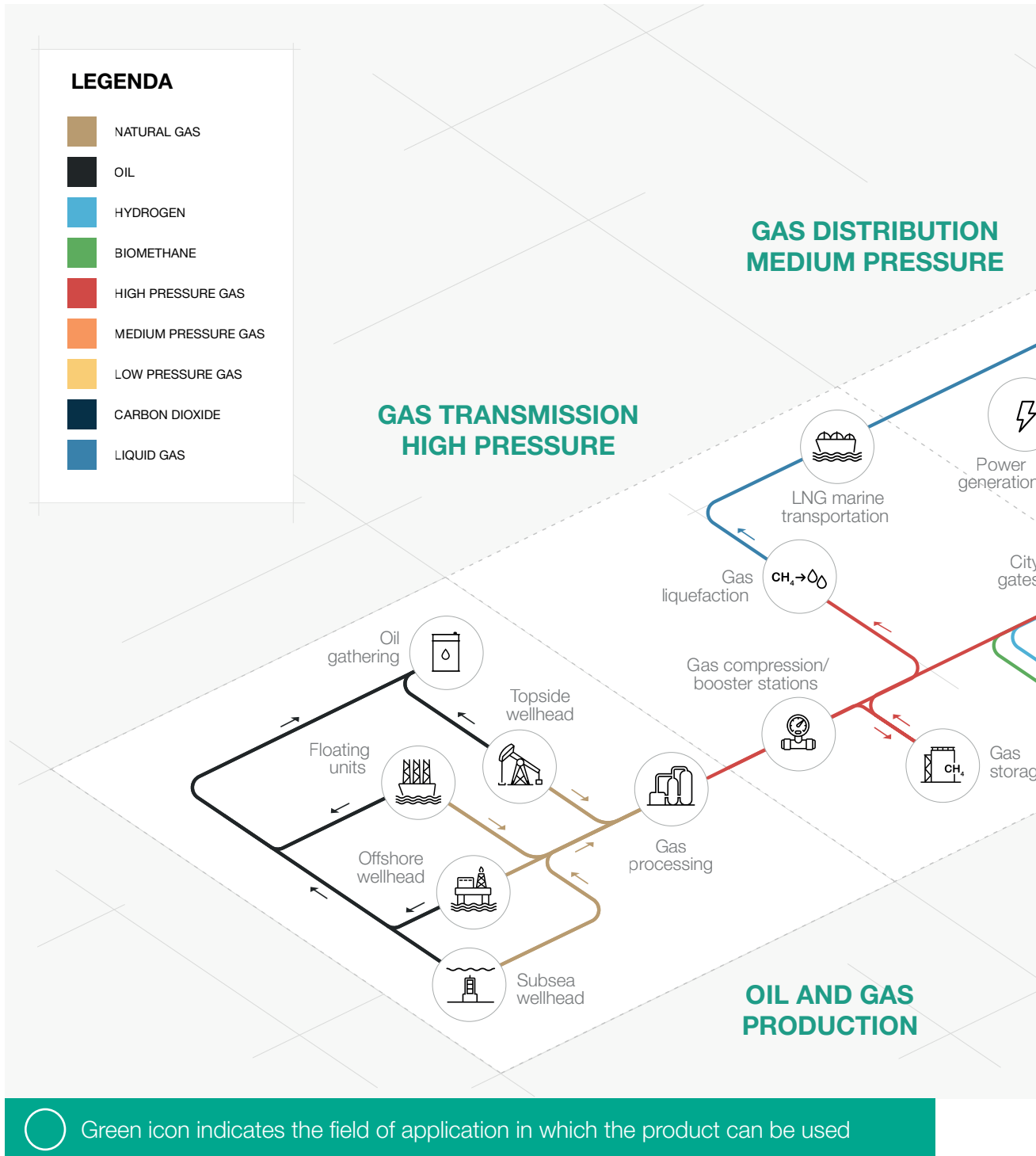

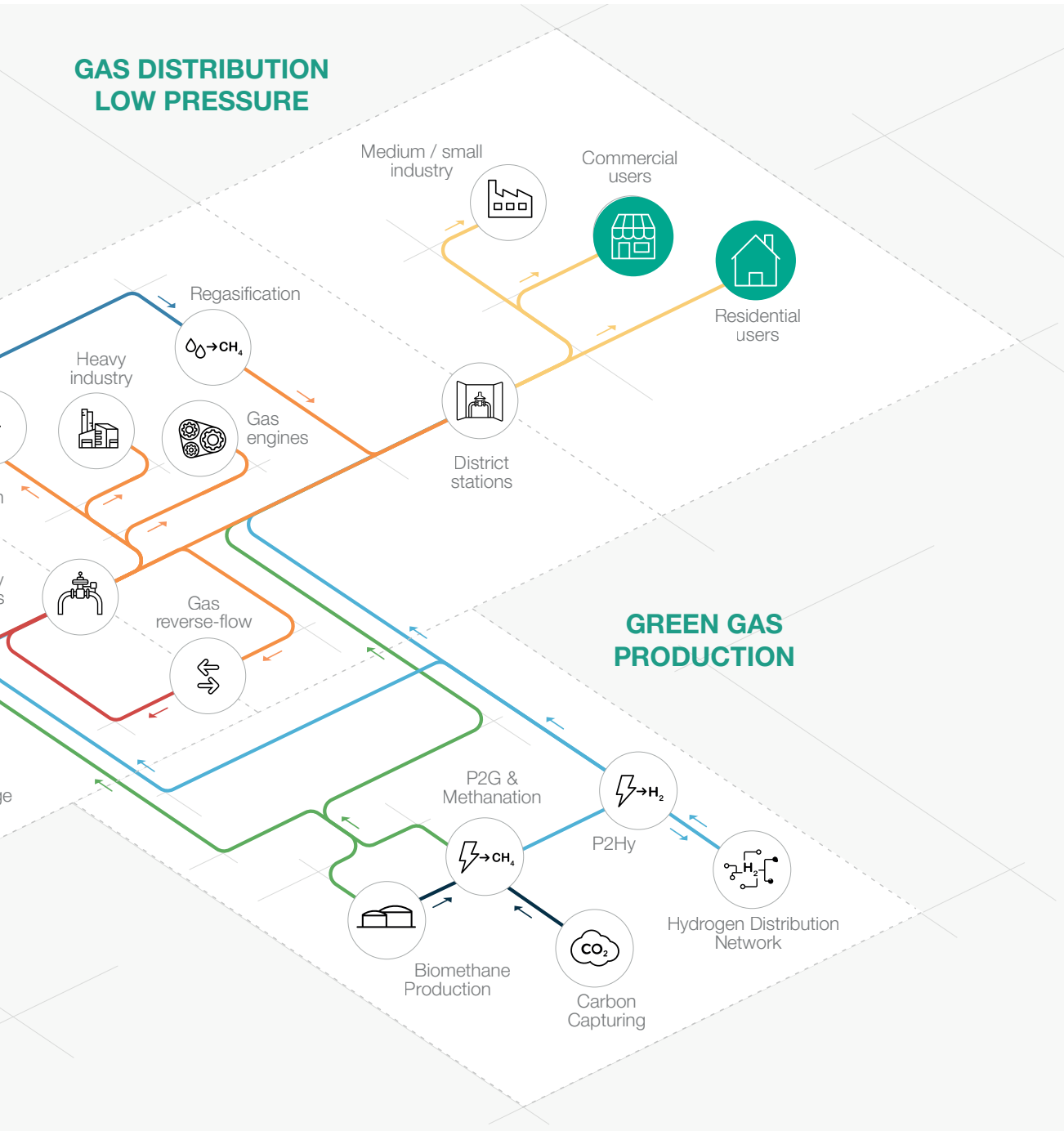

Figure 1 Map of application areas



Introduction

FE is one of the **direct-operated gas pressure regulators** designed and manufactured by Pietro Fiorentini.

This device is suitable for use with previously filtered, non-corrosive gases and is particularly indicated for low-pressure natural gas distribution networks for residential and commercial fixtures.

The **FE** regulator is classified as **Fail Close** (only version with slam-shut device valve for downstream overpressure).

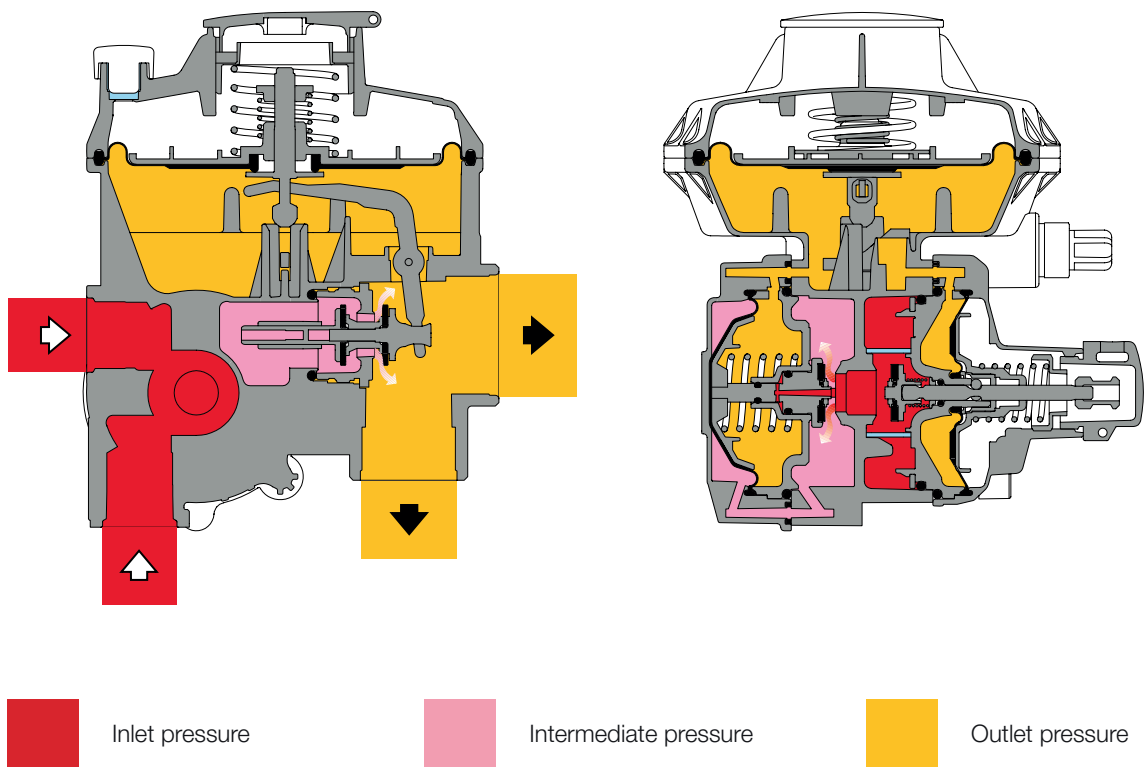

Figure 2 FE

Description and Calibration interval

FE is a **direct-operated pressure regulator** that provides extremely accurate control of the outlet pressure.









The two-stage regulation system with a balanced first stage, combined with a second lever stage, ensures a constant downstream pressure value as the inlet pressure and the required flow rate vary.

This regulator is suitable for use with previously filtered, non-corrosive gases, in natural gas transmission and distribution networks as well as low load residential application.

The design of the **FE** regulator allows for easy installation in all the inlet and outlet pipe positions that the field conditions may have.

The FE regulator is also set up for customisation in terms of calibration, compression fittings, safety devices, etc.

FE competitive advantages

-  Operates with low differential pressure
-  Built-in filter
-  Slam-shut valve for overpressure
Slam-shut valve for underpressure
-  Integrated flow limiter valve option
-  Two-stage regulation with balanced first stage plug
-  Suitable for outdoor installations
-  High customisation
-  Compatible with biomethane and blended hydrogen up to 20%.
Higher mixtures available on request
-  Integrated thermal valve option

Features

Features	Values	
Design pressure (DP)	0.86 MPa 8.6 bar	
Inlet pressure range	0.01 - 0.7 MPa (on request up to 0.86 MPa) 0.1 - 7 bar (on request up to 8.6 bar)	
Regulator capacity	212 - 1765 ft ³ /h 6 - 50 m ³ /h	
Adjustment range of downstream pressure	BP Version	1.3 - 18 KPa 13 - 180 mbar
	TR Version	18.1 - 50 KPa 181 - 500 mbar
Accuracy class (AC)	10	
Lock-up over pressure (SG)	20	
Operating ambient temperature*	Standard version	from -20 °C to +60 °C from -4 °F to +140 °F
	Extended minimum temperature version	from -30°C to +60°C from -22 °F to +140 °F
	Low temperature version (Subzero)	from -40°C to +60°C from -40 °F to +140 °F
Permissible gas temperature	Standard version	from -10°C to +60°C from +14 °F to +140 °F
	Extended minimum temperature version	from -15°C to +60°C from +5 °F to +140 °F
	Low temperature version (Subzero)	from -20 °C to +60 °C from -4 °F to +140 °F
Inlet connection	G ½" EN ISO 228/1 (modular connections on request)	
Outlet connection	<ul style="list-style-type: none"> In-line outlet: G 1" EN ISO 228/1 Outlet in a square pattern: G ¾" EN ISO 228/1 (modular connections on request)	
Modular connections	<ul style="list-style-type: none"> Gas (as per UNI EN ISO 228-1:2003); Flat swivel joint (as per NF E29-533: 2014 and NF E29-536: 2017); NPT (according to ASME B1.20.1, excluding connections with metal/metal sealing); Special accessories (on request). 	
(*) REMARK: Different functional features and/or extended temperature ranges available on request. Stated temperature ranges are the maximum for which the equipment's full performance, including accuracy, are fulfilled. Standard product may have a narrower range.		

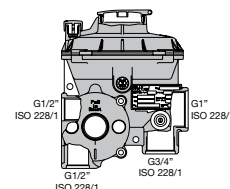

Table 1 Features

Materials and Approvals

Part	Material
<ul style="list-style-type: none"> • Diaphragm • O-rings 	Nitrile rubber (TR rubberised canvas)
<ul style="list-style-type: none"> • Caps • Discs 	Plastic
<ul style="list-style-type: none"> • Springs 	Steel
<ul style="list-style-type: none"> • Equipment body • Lids • Seat 	Zama metal alloy
<ul style="list-style-type: none"> • Equipment body • Lids 	Aluminium alloy (on request) (standard for CSA version)

NOTE: the materials indicated above refer to the standard models. Different materials can be provided according to specific needs.

Table 2 Materials

Construction Standards and Approvals

The **FE** regulator is designed in compliance with European standard EN 13611.

Based on the version/configuration, the FE regulator complies with:



EN 13611



UNI 8827



EN 16129



EN 88-2



UNI 11655



CSA 6.18



ANSI
B109.4



NF
E29-190-2



Spring ranges

BP FE6-10-25 VERSION							
Pos.	Spring item code	Spring colour	d	Lo	De	Spring range (mbar)	
						Min.	Max.
1	64470358BL	Blue	1.6	41	34	13	17
2	64470359AR	Orange	1.7	41	34	17	22
3	64470360VE	Green	1.8	40	34	22	28
4	64470361RO	Red	2	38	34	28	38
5	64470362AZ	Sky blue	2.1	39	34	38	52
6	64470363BI	White	2.3	38	34	52	75
7	64470368MA	Brown	2.4	37	34	75	100
8	64470364GR	Grey	2.6	35	34	100	140
9	64470365NE	Black	2.8	35	34	140	180

d = Wire Diameter (mm) **Lo** = Spring Length (mm) **De** = External Diameter (mm)

Table 3 BP FE6-10-25 version calibration

BP FES VERSION							
Pos.	Spring item code	Spring colour	d	Lo	De	Spring range (mbar)	
						Min.	Max.
1	64470410ZB	White	1.3	46	34	13	16
2	64470187RO	Red	1.4	38	34	16	19
3	64470358BL	Blue	1.6	41	34	19	23
4	64470359AR	Orange	1.7	41	34	23	28
5	64470360VE	Green	1.8	40	34	28	34
6	64470361RO	Red	2	38	34	34	44
7	64470362AZ	Sky blue	2.1	39	34	44	55
8	64470363BI	White	2.3	38	34	55	75
9	64470368MA	Brown	2.4	37	34	75	100
10	64470364GR	Grey	2.6	35	34	100	140
11	64470365NE	Black	2.8	35	34	140	180

d = Wire Diameter (mm) **Lo** = Spring Length (mm) **De** = External Diameter (mm)

Table 4 BP FES version calibration

SLAM-SHUT VALVE BP FE6-10-25-S								
Pos.	Spring item code	Spring colour	d	Lo	De	Spring range (mbar)		
						Min.	Max.	
1	6447038700	-	1	30	18	25	34	
2	64470120BLU	Blue	1.1	29	18	35	50	
3	64470121GI	Yellow	1.3	30	18	51	79	
4	64470122VE	Green	1.3	36.5	18	80	109	
5	64470123ROS	Red	1.5	31.5	18	110	159	
6	64470124AZ	Sky blue	1.6	34	18	160	219	
7	64470020MAR	Brown	1.7	35	18	220	300	

d = Wire Diameter (mm) **Lo** = Spring Length (mm) **De** = External Diameter (mm)

Table 5 BP FE6-10-25-S Slam-shut valve calibration

RELIEF VALVE BP FE6-10-25-S								
Pos.	Spring item code	Spring colour	d	Lo	De	Spring range (mbar)		
						Min.	Max.	
1	64470389BI	White	8	37	15	7	7	
2	64470213BL	Blue	0.9	37	15	8	10	
3	64470029GIA	Yellow	1	35	15	11	19	
4	64470027VER	Green	1.2	30	15.4	20	49	
5	64470162ROS	Red	1.4	30	15.5	50	75	
6	64470024BI	White	1.3	45	15	76	120	

d = Wire Diameter (mm) **Lo** = Spring Length (mm) **De** = External Diameter (mm)

Table 6 Relief valve calibration BP FE6-10-25-S;

*the spring ranges refer to the differential between the regulator calibration and relief activation.

TR FE6-10-25 VERSION								
Pos.	Spring item code	Spring colour	d	Lo	De	Spring range (mbar)		
						Min.	Max.	
1	64470368MA	Brown	2.4	37	34	180	220	
2	64470364GR	Grey	2.6	35	34	220	300	
3	64470365NE	Black	2.8	35	34	300	400	
4	64470366VI	Purple	3	38	34	400	500	

d = Wire Diameter (mm) **Lo** = Spring Length (mm) **De** = External Diameter (mm)

Table 7 TR FE6-10-25 version calibration



TR FES VERSION							
Pos.	Spring item code	Spring colour	d	Lo	De	Spring range (mbar)	
						Min.	Max.
1	64470368MA	Brown	2.4	37	34	180	220
2	64470364GR	Grey	2.6	35	34	220	300
3	64470365NE	Black	2.8	35	34	300	400
4	64470366VI	Purple	3	38	34	400	500

d = Wire Diameter (mm) **Lo** = Spring Length (mm) **De** = External Diameter (mm)

Table 8 TR FES version calibration

SLAM-SHUT VALVE TR FE6-10-25-S							
Pos.	Spring item code	Spring colour	d	Lo	De	Spring range (mbar)	
						Min.	Max.
1	64470169GR	Grey	2	3	20	300	499
2	64470168BI	White	2.2	28	20.2	500	800

d = Wire Diameter (mm) **Lo** = Spring Length (mm) **De** = External Diameter (mm)

Table 9 TR FE6-10-25-S Slam-shut valve calibration

RELIEF VALVE TR FE6-10-25-S							
Pos.	Spring item code	Spring colour	d	Lo	De	Spring range (mbar)	
						Min.	Max.
1	64470029GIA	Yellow	1	35	15	75	149
2	64470027VER	Green	1.2	30	15.4	150	250

d = Wire Diameter (mm) **Lo** = Spring Length (mm) **De** = External Diameter (mm)

Table 10 Relief valve calibration TR FE6-10-25-S;

*the spring ranges refer to the differential between the regulator calibration and relief activation.

General link to the calibration tables: [CLICK HERE](#) or use the QR code:



Versions

























		models		
		FE	FE NO MAX	FE CSA
Image				
Description		Standard version	Version without overpressure slam-shut device	Specific version for the North American market
Available versions	ZK Zama version			
	AI Aluminium version			
	EFV Flow rate limiter			
	OPSO Downstream overpressure slam-shut device			
	 Relief valve			
	 Configuration of 4 types of compression fittings			
	 Outdoor installation not protected			
	 Univent version			

Table 11 Available versions of the FE regulator



Weights and dimensions

FE STD

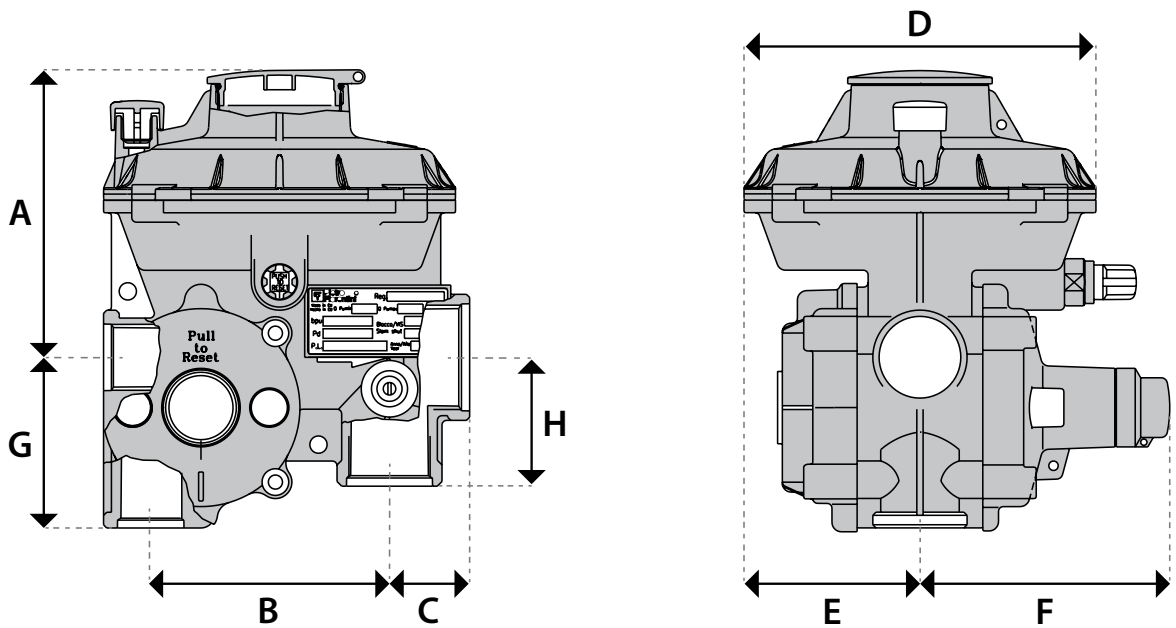

Figure 3 FE STD Dimensions

Weights and Dimensions (for other connections, please contact your closest Pietro Fiorentini representative)		
	[mm]	inches
A	91	3.6"
B	76	3.0"
C	25.5	1.0"
D	Ø112	Ø4.4"
E	56	2.2"
F	79	3.1"
G	54.3	2.1"
H	41	1.6"
Weight	Kg	pounds
Zamak regulator (without fittings)	1.35	2.98
Aluminium regulator (without fittings)	1.0	2.20
Heavier compression fittings	from 0.15 to 0.7	1.57

Table 12 Weights and dimensions

FE NO MAX

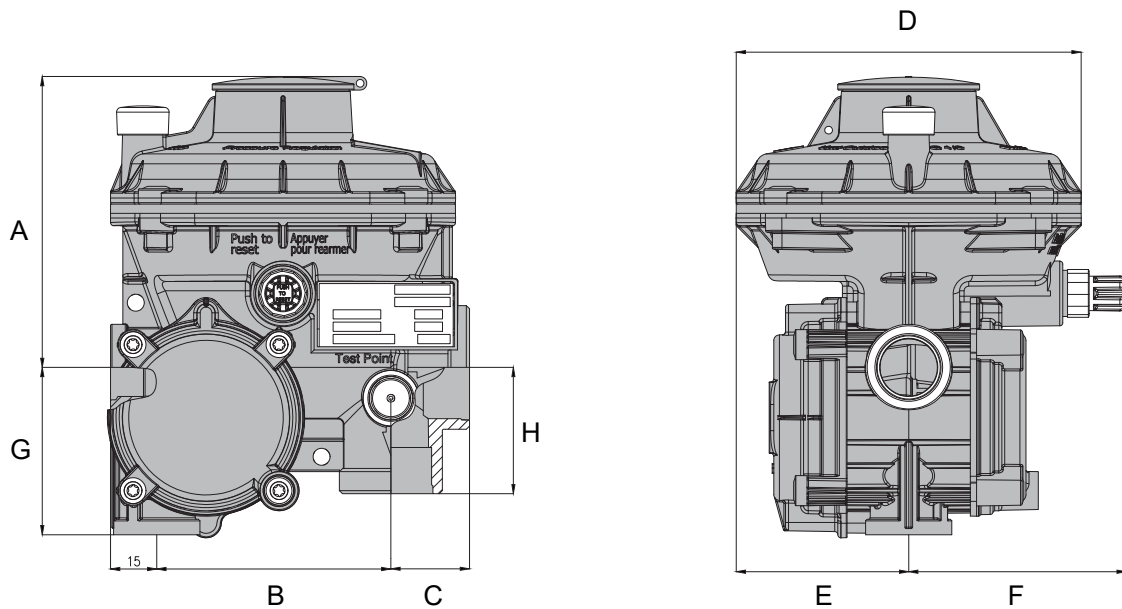

Figure 4 FE NO MAX Dimensions

Weights and Dimensions (for other connections, please contact your closest Pietro Fiorentini representative)		
	[mm]	inches
A	91	3.6"
B	76	3.0"
C	25.5	1.0"
D	Ø112	Ø4.4"
E	56	2.2"
F	71	2.78"
G	54.3	2.1"
H	41	1.6"
Tubing connections	eØ 10 x iØ 8 (on request imperial sizing)	
Weight	Kg	pounds
Zamak regulator (without fittings)	1.3	2.85
Heavier compression fittings	from 0.15 to 0.7	1.57

Table 13 Weights and dimensions



FE CSA

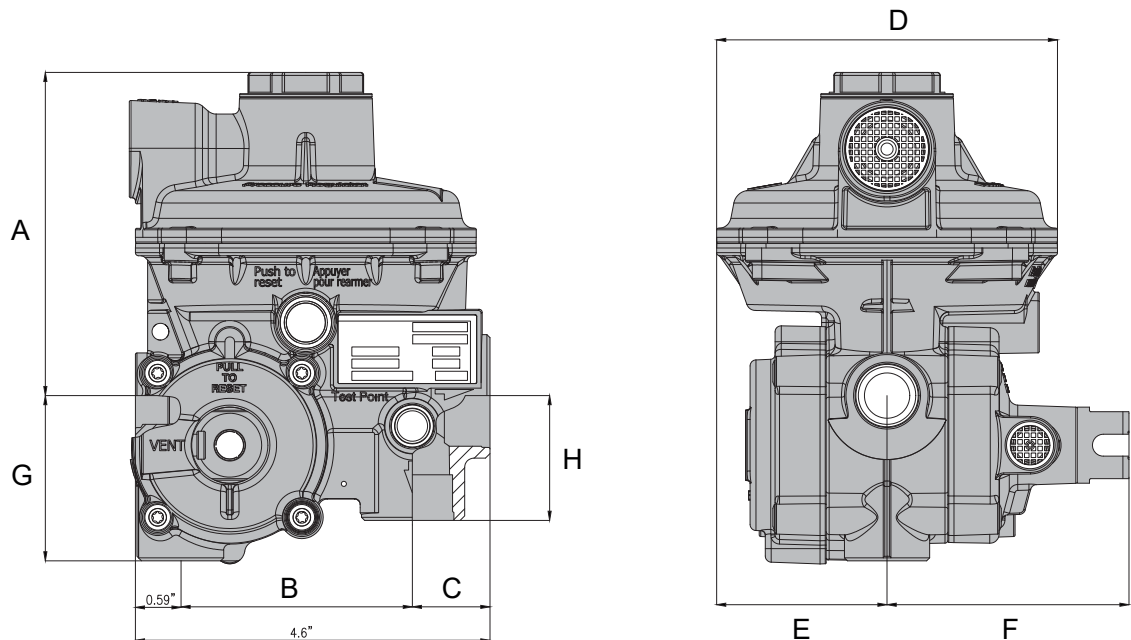

Figure 5 FE CSA Dimensions

Weights and Dimensions (for other connections, please contact your closest Pietro Fiorentini representative)		
	[mm]	inches
A	106.5	4.18"
B	76	3.0"
C	25.5	1.0"
D	Ø112	Ø4.4"
E	56	2.2"
F	79	3.1"
G	54.3	2.1"
H	41	1.6"
Weight	Kg	pounds
Aluminium regulator (without fittings)	1.0	2.20
Heavier compression fittings	from 0.15 to 0.7	1.57

Table 14 Weights and dimensions

Customer Centricity

Pietro Fiorentini is one of the main Italian international companies with high focus on product and service quality.

The main strategy is to create a stable long-term oriented relationship, putting the customer's needs first. Lean management and thinking and customer centricity are used to improve and maintain the highest level of customer experience.



Support

One of Pietro Fiorentini's top priorities is to provide support to the client in all phases of project development, during installation, commissioning and operation. Pietro Fiorentini has developed a highly standardized intervention management system, which helps to facilitate the entire process and effectively archive all the interventions carried out, drawing on valuable information to improve the product and service. Many services are available remotely, avoiding long waiting times or expensive interventions.



Training

Pietro Fiorentini offers training services available for both experienced operators and new users. The training is composed of the theoretical and the practical parts, and is designed, selected and prepared according to the level of use and the customer's need.



Customer Relation Management (CRM)

The centrality of customer is one of the main missions and vision of Pietro Fiorentini. For this reason, Pietro Fiorentini has enhanced the customer relation management system. This enables to track every opportunity and request from Customer in one single point and make free the information flow.



Sustainability

Here at Pietro Fiorentini, we believe in a world capable of improvement through technologies and solutions that can shape a more sustainable future. That is why respect for people, society and the environment form the cornerstones of our strategy.



Our commitment to the world of tomorrow

While in the past we limited ourselves to providing products, systems and services for the oil & gas sector, today we want to broaden our horizons and create technologies and solutions for a digital and sustainable world, with a particular focus on renewable energy projects to help make the most of our planet's resources and create a future in which the younger generations can grow and prosper.

The time has come to put the why we operate before the what and how we do it.





**Pietro
Fiorentini**



Pietro Fiorentini

TB0079ENG



The data are not binding. We reserve the right
to make changes without prior notice.

modfe_technicalbrochure_ENG_revA

www.fiorentini.com