

iM-TM

Turbine meter



Revision B - Edition 07/2023



**USE, MAINTENANCE
AND WARNING
MANUAL**

1 - INTRODUCTION

FOREWORD

All rights reserved. No part of this publication may be reproduced, distributed, translated into other languages or transmitted by any electronic or mechanical media, including photocopies, recording or any other storage and retrieval system, for any other purposes that are not exclusively the personal use of the buyer, without the express written permission of the Manufacturer.

The manufacturer is in no way responsible for the consequences of operations carried out in a manner not in accordance with the manual.

GENERAL REMARKS

All operating, maintenance instructions and recommendations described in this manual must be followed to in order to:

- obtain the best possible performance from the equipment;
- keep the equipment in efficient conditions.

Training the personnel in charge is essential in order to:

- use and service the equipment properly;
- correctly apply the safety alerts and recommended procedures.

Revision: B

1.1 - REVISION HISTORY

Revision index	Date	Revision contents
A	02/2023	First issue
B	07/2023	<ul style="list-style-type: none">• Updated product images• Updated high-frequency (HF) sensor pulse output data

Tab. 1.1.

TABLE OF CONTENTS

1 - INTRODUCTION	3
1.1 - REVISION HISTORY.....	5
2 - GENERAL INFORMATION	11
2.1 - MANUFACTURER IDENTIFICATION	11
2.2 - IDENTIFICATION OF THE PRODUCT	11
2.3 - REGULATORY FRAMEWORK.....	11
2.4 - WARRANTY	12
2.5 - ADDRESSEES, SUPPLY AND STORAGE OF THE INSTRUCTION MANUAL	12
2.6 - LANGUAGE	12
2.7 - SYMBOLS USED IN THE MANUAL.....	13
2.8 - APPLIED RATING PLATES	14
2.8.1 - GLOSSARY FOR NAMEPLATES	16
2.9 - GLOSSARY OF MEASUREMENT UNITS.....	17
2.10 - QUALIFIED PROFESSIONAL FIGURES.....	18
3 - SAFETY	19
3.1 - GENERAL SAFETY WARNINGS.....	19
3.2 - PERSONAL PROTECTIVE EQUIPMENT.....	20
3.3 - OBLIGATIONS AND PROHIBITIONS	21
3.4 - RESIDUAL RISKS	21
3.4.1 - RISKS DUE TO PRESSURE	22
3.4.2 - RISKS DUE TO EXPLOSIVE ATMOSPHERES	24
3.4.3 - EXPLOSION RISK	25
3.5 - SAFETY PICTOGRAMS	26
3.6 - RISK LEVEL	26

4 - DESCRIPTION AND OPERATION 27

4.1 - GENERAL DESCRIPTION AND OPERATION	27
4.1.1 - MEASURING CARTRIDGE UNIT	28
4.1.2 - TOTALISER UNIT	29
4.1.3 - METROLOGICAL SEALS	30
4.2 - ACCESSORIES.....	31
4.2.1 - HIGH FREQUENCY SENSOR.....	31
4.3 - INTENDED USE	32
4.3.1 - ENVISAGED USE	32
4.3.2 - REASONABLY FORESEEABLE MISUSE	32
4.4 - TECHNICAL FEATURES/PERFORMANCE	33
4.5 - POSSIBLE CONFIGURATIONS AND OPERATING CONDITIONS	34
4.6 - OIL REFRESHING & FLUSHING LUBRICATION SYSTEM	37

5 - TRANSPORT AND HANDLING 39

5.1 - SPECIFIC WARNINGS FOR TRANSPORT AND HANDLING	39
5.2 - PACKAGING AND FASTENERS USED FOR TRANSPORT	40
5.2.1 - PACKAGING CONTENT	41
5.3 - PHYSICAL CHARACTERISTICS IM-TM (ALUMINIUM BODY).....	42
5.4 - PHYSICAL CHARACTERISTICS IM-TM (STEEL BODY).....	43
5.5 - EQUIPMENT ANCHORING AND LIFTING METHOD.....	44
5.5.1 - HANDLING WITH FORKLIFT TRUCK	45
5.5.2 - CRANE HANDLING.....	47
5.6 - PACKAGING REMOVAL.....	48
5.6.1 - PACKAGING DISPOSAL	49
5.7 - STORAGE AND ENVIRONMENTAL CONDITIONS	50
5.7.1 - STORAGE LASTING LONGER THAN THE MAXIMUM TIME ALLOWED	50

6 - INSTALLATION 51

6.1 - SPECIFIC SAFETY WARNINGS	51
6.2 - INSTALLATION PRE-REQUISITES.....	52
6.2.1 - ALLOWED ENVIRONMENTAL CONDITIONS.....	52
6.2.2 - STORAGE LASTING LONGER THAN THE MAXIMUM TIME ALLOWED	52
6.2.3 - CHECKS BEFORE INSTALLATION	52
6.3 - GENERAL INFORMATION ON THE LINE	54
6.3.1 - POSITIONING FITTINGS AND ACCESSORIES.....	55
6.4 - INSTALLATION PROCEDURES.....	56
6.4.1 - EQUIPMENT INSTALLATION.....	56
6.4.1.1 - TIGHTENING TORQUES	58
6.4.2 - ELECTRICAL CONNECTIONS	58
6.4.2.1 - LOW-FREQUENCY SENSOR IMPULSE OUTPUT (LF).....	59
6.4.2.2 - HIGH-FREQUENCY (HF) SENSOR IMPULSE OUTPUT.....	60
6.5 - POST-INSTALLATION INSTRUCTIONS	61
6.6 - LUBRICATION.....	61
6.6.1 - FILLING THE PISTON OIL PUMP TANK	62
6.6.2 - FILLING THE LEVER OIL PUMP TANK	64
6.7 - EQUIPMENT ADJUSTMENTS.....	65

7 - COMMISSIONING/MAINTENANCE EQUIPMENT..... 67

7.1 - LIST OF EQUIPMENT.....	67
------------------------------	----

8 - COMMISSIONING 69

8.1 - GENERAL WARNINGS	69
8.1.1 - SAFETY REQUIREMENTS FOR COMMISSIONING	69
8.2 - PRELIMINARY PROCEDURES FOR COMMISSIONING	70
8.3 - METER COMMISSIONING.....	71

9 - MAINTENANCE AND FUNCTIONAL CHECKS..... 73

9.1 - GENERAL WARNINGS	73
9.2 - MAINTENANCE OPERATIONS.....	74
9.2.1 - OPERATIONS PRIOR TO MAINTENANCE.....	74
9.3 - ROUTINE MAINTENANCE	75
9.3.1 - PERIODICALLY CHECKING AND INSPECTING THE EQUIPMENT FOR PROPER OPERATION	75
9.3.2 - LUBRICATION.....	76
9.3.2.1 - PISTON OIL PUMP LUBRICATION	76
9.3.2.2 - LEVER OIL PUMP LUBRICATION	76
9.3.3 - CLEANING THE PISTON OIL PUMP TANK	77
9.3.4 - BLEEDING AND CLEANING THE LEVER OIL PUMP TANK.....	78
9.3.5 - TOPPING UP OIL.....	79
9.4 - EXTRAORDINARY MAINTENANCE.....	80
9.4.1 - UNINSTALLING THE METER.....	81

10 - TROUBLESHOOTING..... 83

10.1 -GENERAL WARNINGS	83
10.2 -OPERATOR QUALIFICATION SPECIFICATION	84
10.3 -TROUBLESHOOTING	84
10.4 -TROUBLESHOOTING TABLES	85

11 - UNINSTALLATION AND DISPOSAL 87

11.1 -GENERAL SAFETY WARNINGS.....	87
11.2 -QUALIFICATION OF THE OPERATORS IN CHARGE.....	87
11.3 -UNINSTALLATION.....	87
11.4 -INFORMATION REQUIRED IN CASE OF RE-INSTALLATION.....	88
11.5 -DISPOSAL INFORMATION.....	88
11.5.1 -EQUIPMENT MATERIALS.....	89

12 - RECOMMENDED SPARE PARTS 91

12.1 -GENERAL WARNINGS	91
12.2 -HOW TO REQUEST SPARE PARTS.....	91
12.3 -SPARE PARTS LIST	91

PAGE INTENTIONALLY LEFT BLANK

2 - GENERAL INFORMATION

2.1 - MANUFACTURER IDENTIFICATION

Manufacturer	PIETRO FIORENTINI S.P.A.
Address	Via Enrico Fermi, 8/10 36057 Arcugnano (VI) - ITALY Tel. +39 0444 968511 Fax +39 0444 960468 www.fiorentini.com sales@fiorentini.com

Tab. 2.2.

NOTICE!

For any problems with the equipment, please contact PIETRO FIORENTINI S.p.A.

2.2 - IDENTIFICATION OF THE PRODUCT

Equipment	TURBINE METER	
Series	iM-TM	
Available models	<ul style="list-style-type: none"> • G40 • G65 • G100 • G160 • G250 • G400 	<ul style="list-style-type: none"> • G650 • G1000 • G1600 • G2500 • G4000
Versions	<ul style="list-style-type: none"> • CT (Custody Transfer) 	<ul style="list-style-type: none"> • Q (Quantometers)

Tab. 2.3.

NOTICE!

In the manual, reference is made to iM-TM series turbine meters. The name given should be understood to cover the iMTM-CT (custody transfer, for use with third parties) and iMTM-Q (quantometers) range.

2.3 - REGULATORY FRAMEWORK

PIETRO FIORENTINI S.P.A. with registered office in Arcugnano (Italy) - Via E. Fermi, 8/10, declares that the equipment in the iM-TM series covered by this manual is designed, manufactured, tested and controlled as far as applicable in accordance with:

- the requirements of the Directives:
 - 2014/32/EU "MID";
 - 2014/34/EU "ATEX";
 - 2014/68/UE "PED";
- the requirements of the standards:
 - EN 12261:2018.

NOTICE!

Please contact the manufacturer for specific approvals.

NOTICE!

The EU Declaration of Conformity is delivered together with the equipment and this manual.

2.4 - WARRANTY

PIETRO FIORENTINI S.P.A. guarantees that the equipment was manufactured using the best materials, with high quality workmanship, and complies with the quality requirements, specifications and performance set out in the order. The warranty shall be considered null and void and PIETRO FIORENTINI S.P.A. shall not be liable for any damage and/or malfunctions:

- due to any acts or omissions of the purchaser or end-user, or any of their carriers, employees, agents, or any third party or entity;
- in the event that the purchaser, or a third party, makes changes to the equipment supplied by PIETRO FIORENTINI S.P.A. without the prior written approval of the latter;
- in the event of failure by the purchaser to comply with the instructions contained in this manual, as provided by PIETRO FIORENTINI S.P.A.

NOTICE!

The warranty conditions are specified in the commercial contract.

2.5 - ADDRESSEES, SUPPLY AND STORAGE OF THE INSTRUCTION MANUAL

The instruction manual is intended for qualified technicians responsible for operating and managing the equipment throughout its service life.

It contains the necessary information to properly use the equipment and keep its functional and qualitative characteristics unchanged over time. All information and warnings for safe, correct use are also provided.

The manual, as well as the declaration of conformity and/or test certificate, is an integral part of the equipment and must always accompany it whenever it is moved or resold. It is the responsibility of the qualified professionals (see paragraph 2.10) to use and manage the equipment.

WARNING!

Removing, rewriting or modifying the pages of the manual and their contents is not allowed. PIETRO FIORENTINI S.p.A. shall not be held liable for any damage to people, animals and property caused by failure to adhere to the warnings and operating procedures described in this manual.

NOTICE!

The meter illustrations in this manual refer to standard models. PIETRO FIORENTINI S.p.A.:

- reserves the right to change the contents of this manual at any time and without notice;
- disclaims any liability arising from operations not described in this manual.

2.6 - LANGUAGE

The original instruction manual was drawn up in Italian.

Any translations into additional languages are to be made from the original instruction manual.

HAZARD!

The translations into other languages cannot be fully verified. If any inconsistency is found, please refer to the original instruction manual.





If inconsistencies are found or the text does not make sense:

- stop any actions;
- immediately contact PIETRO FIORENTINI S.p.A. at the addresses specified in paragraph 2.1.

WARNING!

PIETRO FIORENTINI S.p.A. shall be held liable for the information provided in the original manual only.

2.7 - SYMBOLS USED IN THE MANUAL

Symbol	Definition
	Symbol used to identify important warnings for the safety of the operator and/or equipment.
	Symbol used to identify an ELECTRICAL HAZARD.
	Symbol used to identify DANGERS GENERATED BY STATIC ELECTRICITY.
	Symbol used to identify information of particular importance in the instruction manual. The information may also concern the safety of the personnel involved in using the equipment.
	Obligation to consult the instruction manual/booklet. Indicates a requirement for the personnel to refer to (and understand) the operating and warning instructions of the machine before working with or on it.

Tab. 2.4.

HAZARD!

Alerts to a hazard with a high level of risk, an imminent hazardous situation which, if not prevented, will result in death or severe damage.

WARNING!

Alerts to a hazard with a medium level of risk, a potentially hazardous situation which, if not prevented, may result in death or severe damage.

ATTENTION!

Alerts to a hazard with a low level of risk, a potentially hazardous situation which, if not prevented, could result in minor or moderate damage.

NOTICE!

Alerts to specific warnings, directions or notes of particular concern, that are not related to physical injury, as well as practices for which physical injury is not likely to occur.

2.8 - APPLIED RATING PLATES







WARNING!

Removing nameplates and/or replacing them with other plates is strictly not allowed. Should the plates be unintentionally damaged or removed, the customer must notify PIETRO FIORENTINI S.p.A.

The equipment and its accessories are provided with nameplates (from Id.1 to Id.4).

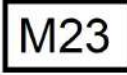
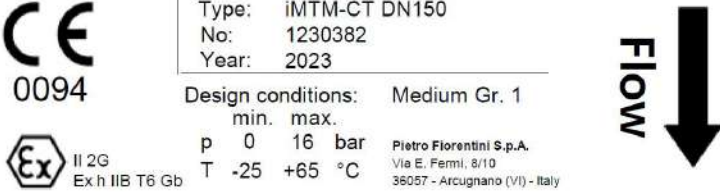
The nameplates specify identification details of the equipment and its accessories to be provided, if necessary, to PIETRO FIORENTINI S.p.A.

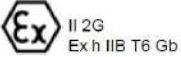
Examples of the rating plates applied:

Id.	Type	Image																								
1	IDENTIFICATION PLATE WITH CE MARKING	 <p>Pietro Fiorentini S.p.A. Via E. Fermi, 8/10 36057 - Arcugnano (VI) - Italy</p> <p>TG013 EN 12261 Class: 1.0 C-ID 3230382</p> <p>Type: iMTM-CT G650 DIN PN16 Year: 2023</p> <p>Qmax: 1000 m³/h Lf: 1 imp/m³ Qmin: 50 m³/h Hf 1: 500.123 imp/m³ Qt: 200 m³/h Hf 2: --- imp/m³ Pmax: 16 bar DN: 150 mm i: 2,9483 Working position: H Env. classes: M1/E2</p> <p>  0407 p = 0 - 4 bar t = -25 +55 °C</p>																								
2	PED INFORMATION PLATE AND FLOW DIRECTION	 <p> 0094</p> <p>Type: iMTM-CT DN150 No: 1230382 Year: 2023</p> <p>Design conditions: Medium Gr. 1 min. max. p 0 16 bar T -25 +65 °C</p> <p> Pietro Fiorentini S.p.A. Via E. Fermi, 8/10 36057 - Arcugnano (VI) - Italy</p> <p>FLOW </p>																								
3	INFORMATION LABEL HAND LEVER OIL PUMP	<p>DON'T ROTATE THE COVER, LIFT IT </p> <p>Lubrication instructions: Oil: Aeroshell Fluid 12 Lubrication interval: every 3 months Procedure: keep oil open, refill reservoir and check descending oil during strokes <i>More information: check latest manual version</i></p> <table border="1"> <thead> <tr> <th>Size</th> <th>ml (or cm³)</th> <th>Strokes</th> </tr> </thead> <tbody> <tr> <td>DN50 / 2"</td> <td>7</td> <td>7</td> </tr> <tr> <td>DN80 / 3"</td> <td>7</td> <td>7</td> </tr> <tr> <td>DN100 / 4"</td> <td>7</td> <td>7</td> </tr> <tr> <td>DN150 / 6"</td> <td>35</td> <td>35</td> </tr> <tr> <td>DN200 / 8"</td> <td>45</td> <td>45</td> </tr> <tr> <td>DN250 / 10"</td> <td>45</td> <td>45</td> </tr> <tr> <td>DN300 / 12"</td> <td>45</td> <td>45</td> </tr> </tbody> </table> <p>OIL PUMP 0010-7100-0111</p>	Size	ml (or cm ³)	Strokes	DN50 / 2"	7	7	DN80 / 3"	7	7	DN100 / 4"	7	7	DN150 / 6"	35	35	DN200 / 8"	45	45	DN250 / 10"	45	45	DN300 / 12"	45	45
Size	ml (or cm ³)	Strokes																								
DN50 / 2"	7	7																								
DN80 / 3"	7	7																								
DN100 / 4"	7	7																								
DN150 / 6"	35	35																								
DN200 / 8"	45	45																								
DN250 / 10"	45	45																								
DN300 / 12"	45	45																								

Tab. 2.5.



Fig. 2.1. Positioning of the rating plates applied

2.8.1 - GLOSSARY FOR NAMEPLATES

The terms and abbreviations used on nameplates are described in Tab. 2.6.:

Term	Description
TG013	EU Type Examination Certificate Number (MID Directive).
EN12261	European Product Standard (Gas Meters - Gas Turbine Meters).
Class	Accuracy class.
C-ID	Cartridge serial number.
Type	Complete name of the meter.
Year	Year of manufacture.
Q_{max}	Maximum capacity.
Q_{min}	Minimum flow rate.
Q_t	Transition flow rate.
P_{max}	Maximum allowable pressure.
i	Gearbox reduction ratio.
L_f	Pulse value / m ³ valid for low-frequency pulse generator.
H_f 1	Number of pulses / m ³ high-frequency output (if any) on the main shaft.
H_f 2	Number of pulses / m ³ high-frequency output (if any) on the impeller.
DN	Nominal diameter.
Working position	Working position (H, VD, VU, HV).
Env. classes	Environmental classes.
CE	CE marking ensuring the conformity of the product with the requirements of the applicable EU directives or regulations.
M23	Additional metrology marking in accordance with Directive 2014/32/EU.
0407	Number of the Notified Body involved in the production control phase.
p	Pressure range (bar).
t	Temperature range (°C).
EX	Specific marking of explosion protection.
Medium Gr. 1	Equipment suitable for use with group 1 hazardous gases according to PED Directive 2014/68/EU.
Flow	Flow direction.

Tab. 2.6.

2.9 - GLOSSARY OF MEASUREMENT UNITS

Type of measurement	Unit of measurement	Description
Volumetric flow rate	Sm ³ /h	Standard cubic metres per hour
	Sm ³	Standard cubic metres
	m ³ /h	Cubic metres per hour
	m ³	Cubic metres
Pressure	bar	Unit of measurement in the CGS system
	“wc	Water column inch
	Pa	Pascal
Temperature	°C	Centigrade degree
	°F	Fahrenheit degree
	K	Kelvin
Tightening torque	Nm	Newton metre
Sound pressure	dB	Decibel
Other measures	V	Volt
	W	Watt
	H	Henry
	A	Ampere
	Ω	Ohm

Tab. 2.7.

2.10 - QUALIFIED PROFESSIONAL FIGURES

Qualified operators in charge of using and managing the equipment throughout its technical service life:

Professional figure	Definition
Mechanical maintenance technician	<p>Qualified technician able to:</p> <ul style="list-style-type: none"> perform preventive/corrective maintenance operations on all mechanical parts of the equipment subject to maintenance or repair; access all device parts for visual inspection, equipment checks, adjustments and calibrations. <p>The maintenance mechanical technician is not authorised to operate on live electrical systems (if any).</p>
Electrical maintenance technician	<p>Qualified technician able to:</p> <ul style="list-style-type: none"> perform preventive/corrective maintenance operations on all electrical parts of the device subject to maintenance or repair; read wiring diagrams and check the correct functional cycle; perform adjustments and operate on electrical systems for maintenance, repair and replacement of worn parts. <p>The electrical maintenance technician can operate in the presence of voltage inside electrical panels, junction boxes, control equipment etc. only if he/she is deemed to be suitable (S.P.).</p> <p>For general requirements, refer to the IEC EN 50110-1:2014 standard.</p>
Worker in charge of transport, handling, unloading and placement on site	<p>Operator qualified to:</p> <ul style="list-style-type: none"> use lifting equipment; handle materials and equipment. <p>The equipment must be lifted and handled strictly in accordance with the instructions provided by the manufacturer as well as the regulations in force at the place where the equipment is installed.</p>
Installer	<p>Qualified operator able to:</p> <ul style="list-style-type: none"> carry out all the operations necessary to properly install the equipment; perform all the operations necessary for the proper functioning of the equipment and the system in safety.
User's technician	<p>Technician trained and authorised to use and manage the equipment for the activities for which it was supplied. They must:</p> <ul style="list-style-type: none"> be able to perform all operations required to properly run the equipment and the system, ensuring their own safety and that of any personnel on site; have proven experience in properly using the equipment similar to that described in this manual, and be trained, informed and instructed in this regard. <p>The technician may carry out maintenance only if authorised/qualified to do so.</p>

Tab. 2.8.

3 - SAFETY

3.1 - GENERAL SAFETY WARNINGS

WARNING!

The equipment described in this instruction manual is:

- a device subjected to pressure in pressurised systems;
- normally installed in systems carrying flammable gases (for example: natural gas).

WARNING!

If the gas used is a combustible gas, the installation area of the equipment is defined as a “danger zone” as there are residual risks that potentially explosive atmospheres may be generated.

In “danger zones” and in close proximity thereto:

- there must not be any effective sources of ignition;
- Smoking and open flames are prohibited.

WARNING!

Never disassemble the equipment in the presence of pressure.

WARNING!

- It is strictly forbidden to repair or make any modifications to the equipment.
- For information and warnings concerning the maintenance of the equipment, please refer to Chapter 9 of this manual.

ATTENTION!

Authorised operators must not carry out operations or services on their own initiative that do not fall within their competence.

Never operate the equipment:

- while under the influence of intoxicating substances such as alcohol;
- if you are using drugs that may slow reaction times.

NOTICE!

The employer must train and inform operators:

- on how to behave during operations;
- on the equipment to be used.

Before installation, commissioning or maintenance, operators must:

- take note of the safety regulations applicable to the place of installation they are working in;
- obtain the necessary permits to operate when required;
- wear the personal protective equipment required by the procedures described in this instruction manual;
- ensure that the required collective protective equipment and safety information are available in the area they are operating in.

3.2 - PERSONAL PROTECTIVE EQUIPMENT

The following table shows the Personal Protective Equipment (PPE) and its description; an obligation is associated with each symbol.

Personal protective equipment means any equipment intended to be worn by the worker in order to protect them against one or several risks that are likely to threaten their safety or health during work.

For the operators in charge, depending on the type of work requested, the most appropriate PPE from those reported in Tab.3.9 must be used:

Symbol	Meaning
	Obligation to use safety or insulated gloves. Indicates a requirement for personnel to use safety or insulated gloves.
	Obligation to use safety goggles. Indicates a requirement for personnel to use protective goggles for eye protection.
	Obligation to use safety shoes. Indicates a requirement for the personnel to use accident-prevention safety shoes.
	Obligation to use noise protection equipment. Indicates a requirement for personnel to use ear muffs or ear plugs to protect their hearing.
	Obligation to wear protective clothing. Indicates a requirement for the personnel to wear specific protective clothing.
	Obligation to use a protective mask. Indicates a requirement for the personnel to use respiratory masks in the event of a chemical risk.
	Obligation to use a protective helmet. Indicates a requirement for the personnel to use protective helmets.
	Obligation to wear high visibility vests. Indicates a requirement for the personnel to use high visibility vests.

Tab. 3.9.

WARNING!

Each licensed operator is obliged to:

- **take care of his/her own health and safety and that of other people in the workplace who are affected by his/her actions or omissions, in accordance with the training, instructions and equipment provided by the employer;**
- **appropriately use the PPE provided;**
- **immediately report to the employer, the manager or the person in charge of the deficiencies of the means and devices as well as any possible dangerous conditions of which they become aware.**

3.3 - OBLIGATIONS AND PROHIBITIONS

The following is a list of obligations and prohibitions to be observed for the safety of the operator:

It is mandatory to:

- carefully read and understand the use, maintenance and warning manual;
- check whether the downstream equipment is suitably sized according to the performance required of the meter in the actual operating condition;
- before installing the equipment, strictly refer to the details specified on the nameplates and in the manual;
- avoid knocks and violent impact that could damage the equipment.

It is forbidden to:

- operate in various capacities on the equipment without the PPE indicated in the work procedures described in this manual;
- operate in the presence of open flames or bring open flames close to the work area;
- smoke near the equipment or while working on it;
- use the equipment with parameters other than those indicated on the nameplate;
- use the equipment with fluids other than those indicated in this manual;
- use the equipment outside the operating temperature range specified in this manual;
- carry out maintenance with the equipment in operation or under pressure;
- dismantle the meter in the presence of gas;
- install or use the equipment in environments other than those specified in this manual.

3.4 - RESIDUAL RISKS

The equipment is suitable for the hazardous area 'Zone 1' for the presence of gas (ATEX marking II 2G).

WARNING!

If there are any functional faults, do not operate.

Immediately contact PIETRO FIORENTINI S.p.A. for the necessary directions.

3.4.1 - RISKS DUE TO PRESSURE

WARNING!

The iM-TM meters:

- are supplied as components to be installed in the end customer's gas system;
- must not be installed where the line pressure may exceed PS.

It is the end customer's responsibility to ensure compliance with the requirements of the directives mentioned in this section.

NOTICE!

The maximum permissible pressure (PS or Pmax) of the meters iM-TM can be found on the nameplate attached (see section 2.8). Each meter is subjected to a test for:

- leakage at 1.1 times PS;
- resistance at 1.5 times PS.

In accordance with the requirements of PED Directive 2014/68/EU point 1.2 of Annex I, below is an assessment of the risks associated with the equipment and an indication of the principles adopted for their prevention, according to the following classification:

Ref. "PED" Directive Annex I	Essential safety requirements	Instructions
2.3	<p>Provisions to ensure safe handling and operation.</p> <p>The method of operation specified for pressure equipment must be such as to preclude any reasonably foreseeable risk in operation of the equipment.</p> <p>Particular attention must be paid, where appropriate, to:</p>	-
	<ul style="list-style-type: none"> • closing and opening devices. 	<p>When removing and replacing any parts (such as oil plugs, sensors or thermowells), the end customer must ensure that:</p> <ul style="list-style-type: none"> • the iM-TM meter was correctly disconnected; • the gas pressure has been safely discharged.
	<ul style="list-style-type: none"> • dangerous discharge of pressure relief valve. 	<p>The meter iM-TM is not equipped with pressure relief valves. Pressure relief valves must be provided on the gas system of the end customer.</p>
	<ul style="list-style-type: none"> • devices to prevent physical access in the presence of pressure or vacuum. 	<p>The end customer must ensure that the iM-TM meter is installed in a system:</p> <ul style="list-style-type: none"> • appropriately designed; • with the possibility of restricting access.
	<ul style="list-style-type: none"> • within the temperature range. 	<p>It is the responsibility of the end customer to assess the expected service surface temperature and, if necessary, to take the necessary precautions.</p> <div style="border: 1px solid black; padding: 5px;"> <p> NOTICE!</p> <p>The temperature range is indicated on the rating plate.</p> </div>
	<ul style="list-style-type: none"> • decomposition of unstable fluids. 	<p>The iM-TM meter is not supposed to come into contact with unstable fluids, in any case the end customer must:</p> <ul style="list-style-type: none"> • assess the risk; • take all measures deemed necessary.

Ref. "PED" Directive Annex I	Essential safety requirements	Instructions
2.4	<p>Means of inspection. The design and manufacturing of the pressure equipment must ensure that all the necessary inspections to ensure its safety can be carried out.</p>	<p>For the inspection of all pressure parts, the iM-TM meter must be removed from the line. It is the responsibility of the end customer to:</p> <ul style="list-style-type: none"> ensure that the internal pressure has been safely discharged before the meter is removed from the line; use appropriate tools; ensure that removal personnel are trained in the assembly and disassembly of high-pressure gas lines and related equipment.
2.5	<p>Means of draining and venting. Where necessary, adequate equipment must be provided for discharging and venting pressure equipment.</p>	<p>The iM-TM meter is not equipped with means of discharge or venting internal pressure. It is the end customer's responsibility to ensure that the equipment is installed in a piping system equipped with venting devices that allow for safe pressure relief.</p>
2.6	<p>Corrosion and other chemical attacks.</p>	<p>The process fluid for which the iM-TM meter is designed is not considered to cause serious corrosion problems. It is the responsibility of the end customer to verify any changes in the fluid. External corrosion is not considered / allowed.</p>
2.7	<p>Wear.</p>	<p>It is not believed that the use of the iM-TM gas meter will cause any anomalies due to wear and tear. It is the responsibility of the end customer to:</p> <ul style="list-style-type: none"> install suitable filters upstream of the meter; ensure that no moisture is present.
2.8	<p>Assemblies.</p>	<p>The iM-TM meter is delivered fully assembled.</p>
2.9	<p>Provisions for filling and discharge.</p>	<p>Pressurise the iM-TM meter carefully while maintaining a pressure gradient of no more than 35 kPa /s (0.35 bar/s).</p>
2.10	<p>Protection against exceeding the allowable limits of pressure equipment.</p>	<p>The iM-TM meter has no integrated pressure limiting devices. It is the responsibility of the end customer to ensure that:</p> <ul style="list-style-type: none"> the iM-TM meter is installed within a gas system with adequate protection against overpressure (e.g. PSV pressure relief valves); temporary pressure peaks are in any case less than 10% of the maximum operating pressure.
2.12	<p>External fire.</p>	<p>The iM-TM meter has no specific accessories to limit the damage caused by a fire. It is the responsibility of the end customer to provide adequate fire-fighting facilities on site.</p>

Tab. 3.10.

3.4.2 - RISKS DUE TO EXPLOSIVE ATMOSPHERES

WARNING!

If the gas used is a combustible gas, the area where the equipment is installed is defined as a 'hazardous area' because there is a residual risk of potentially explosive atmospheres forming where effective ignition sources must be avoided.

NOTICE!

The PIETRO FIORENTINI S.p.A. meters are supplied as components to be installed in the end customer's gas system.
The end user is responsible for ensuring compliance with the requirements of the directive mentioned in this section.

Table 3.11. shows the conditions that can lead to the generation of potentially explosive atmospheres by meters of the iM-TM series according to the requirements of the ATEX Directive 2014/34/EU point 1.0.6:

Operating conditions	Essential safety requirements	Management measures included in the use, maintenance and warning manual	
Installation	During the equipment installation: <ul style="list-style-type: none"> outdoors; in a naturally ventilated environment. 	In the manual, the need for hazard area classification according to EN 60079-10-1 is indicated (by the end customer).	
	The installation room temperature must respect the range -25°C to +55°C	The manual indicates the need to respect the temperature range.	
	Intrinsically safe electrical connections.		The manual indicates the characteristics and reference parameters for electrical connections which must only be made on intrinsically safe circuits.
			LF and HF pulse generators are sealed by PIETRO FIORENTINI S.p.A. and cannot be opened or repaired.
			Intrinsically safe light curtains (Zener) must be installed outside areas classified as potentially explosive.
		The connections of LF and HF pulse generators must be made with appropriate connectors supplied by PIETRO FIORENTINI S.p.A..	
First start-up	Before commissioning, the external tightness of the portion of the system on which the equipment is installed must be tested at a suitable pressure.	The manual indicates the need to fulfil this requirement.	
Use in normal conditions	The installation is subject to surveillance according to; <ul style="list-style-type: none"> national rules in force; good practice; the equipment manufacturer's manual. 	The manual reports that periodic checks must be carried out during the life of the equipment.	
Maintenance	Any repair or maintenance work when the equipment is pressurised or in operation is prohibited.	The manual indicates the need to fulfil this requirement.	

Operating conditions	Essential safety requirements	Management measures included in the use, maintenance and warning manual
Decommissioning	<ul style="list-style-type: none"> The section of the plant in which the equipment is installed must be depressurised. The residual gas must be discharged safely. 	The manual indicates the need to fulfil this requirement.

Tab. 3.11.

3.4.3 - EXPLOSION RISK

 **WARNING!**

The equipment is suitable for installation in hazardous areas in connection with explosive gas atmospheres "zone 1", i.e. areas in which an explosive atmosphere due to the presence of gas during normal operation may be present periodically or occasionally.

In these areas any sparks produced by electrostatic discharges, of electrical origin, of mechanical origin, hot surfaces, flames, stray electric currents, can produce explosions.

 **WARNING!**

During the various operational phases (installation, configuration and maintenance) of the equipment, it is mandatory to implement electrostatic discharge protection measures.

 **NOTICE!**

PIETRO FIORENTINI S.p.A. disclaims any liability resulting from the risks and consequences caused by non-compliance with these provisions.

The authorised operator must proceed as follows, during the various operational phases, to avoid the risk:

Operational phase	Obligations of the operator
Installation	<ul style="list-style-type: none"> Wear professional safety footwear with ESD characteristics; Wear work clothes that dissipate electrostatic charges; Use a damp cloth for cleaning.
Configuration	<ul style="list-style-type: none"> Wear professional safety footwear with ESD characteristics; Wear work clothes that dissipate electrostatic charges.
Maintenance	<ul style="list-style-type: none"> Wear professional safety footwear with ESD characteristics; Wear work clothes that dissipate electrostatic charges; Use a damp cloth for cleaning.

Tab. 3.12.

3.5 - SAFETY PICTOGRAMS

 **HAZARD!**

It is absolutely forbidden to remove any safety pictograms that may be on the equipment or packaging. The user is obliged to replace safety pictograms which, as a result of wear and tear, removal or tampering are illegible (contact PIETRO FIORENTINI S.p.A. for this).

3.6 - RISK LEVEL

Depending on the operating conditions, use and configuration required, the equipment may generate noise beyond the limits allowed by current legislation in the country of installation.

For the value of the noise generated by the equipment and further information, contact PIETRO FIORENTINI S.p.A.

 **ATTENTION!**

The obligation to use earmuffs or ear plugs to protect the hearing of qualified professional figures (reference paragraph 2.10) remains in the event that the noise in the installation environment of the equipment (depending on specific operating conditions) exceeds the value of 85 dBA.

4 - DESCRIPTION AND OPERATION

4.1 - GENERAL DESCRIPTION AND OPERATION

The equipment iM-TM is a turbine used for gas flow measurement applications. Turbine meters iM-TM, approved for custody transfer applications, are mainly used for:

- high-pressure transmission systems;
- electric power plants;
- heavy industry;
- medium-low pressure natural gas distribution networks.

A straightening section in the meter body conditions the gas flow by removing undesired vortices and turbulence before the flow reaches the turbine rotor.

The dynamic forces from gas flow initiate rotation of the turbine rotor. With each rotation, a turbine wheel mounted on the main shaft and a counting mechanism (totaliser unit) measure the volume of gas.

The volume of gas transferred is proportional to the number of revolutions of the turbine.

The main elements of the equipment are specified in Tab.4.13:

Pos.	Description	Pos.	Description
1	Body	6	High frequency sensor on main shaft (optional)
2	Measuring cartridge assembly (see par. 4.1.1)	7	High-frequency sensor on turbine wheel (optional)
3	Totalising group (see section 4.1.2): a. totaliser; b. LF connection.	8	Lubrication system: a. piston oil pump; b. hand lever oil pump.
4	Flange ring	9	Pr
5	O-ring	10	Tm

Tab. 4.13.

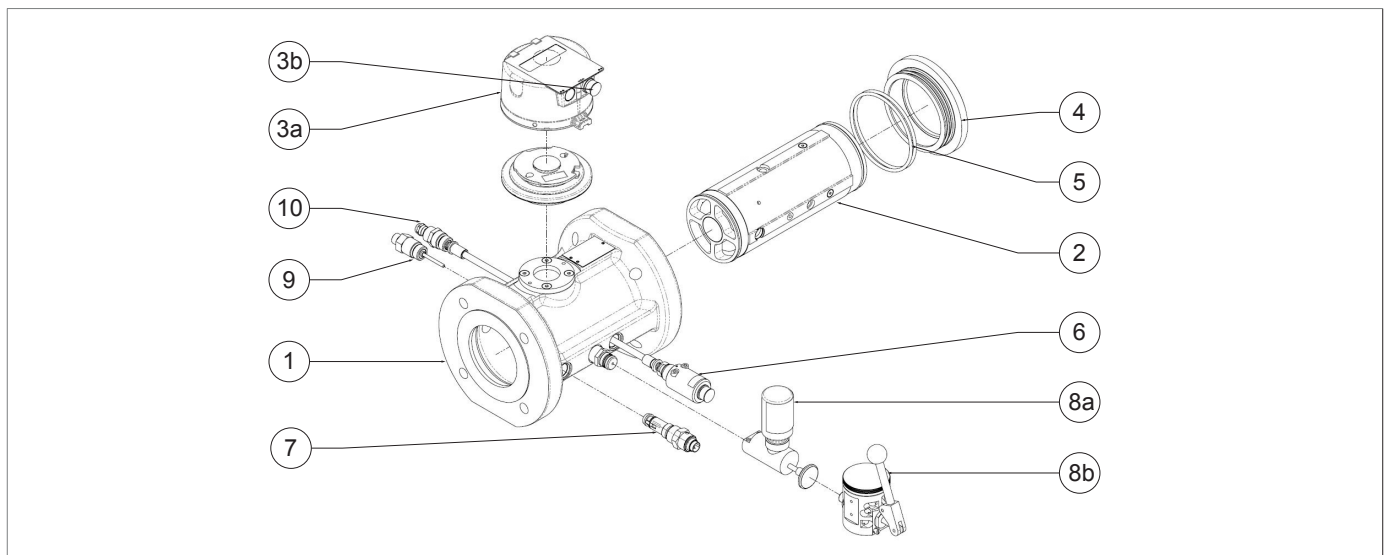

Fig. 4.2. General description iM-TM

4.1.1 - MEASURING CARTRIDGE UNIT

! NOTICE!

If flow parameters change customers can change the measurement cartridge.

The removable measuring cartridge allows:

- changing the flow capacity of the meter;
- flexibility for stations requiring increased measurement capacity.

Turbine counters iM-TM are available with four different measuring cartridge sizes per body. This feature offers modular flexibility in terms of minimum and maximum capacity, in accordance with European Standard EN 12261.

The main elements of the group are listed in Table 4.14:

Pos.	Description	Pos.	Description
1	Measuring chamber	5	Bearing housing
2	First rectifier: a. type 1; b. type 2.	6	Turbine wheel
3	Second rectifier	7	Pressure compensation ring
4	Magnet for HF	8	Third rectifier

* Detail not visible in figure

Tab. 4.14.

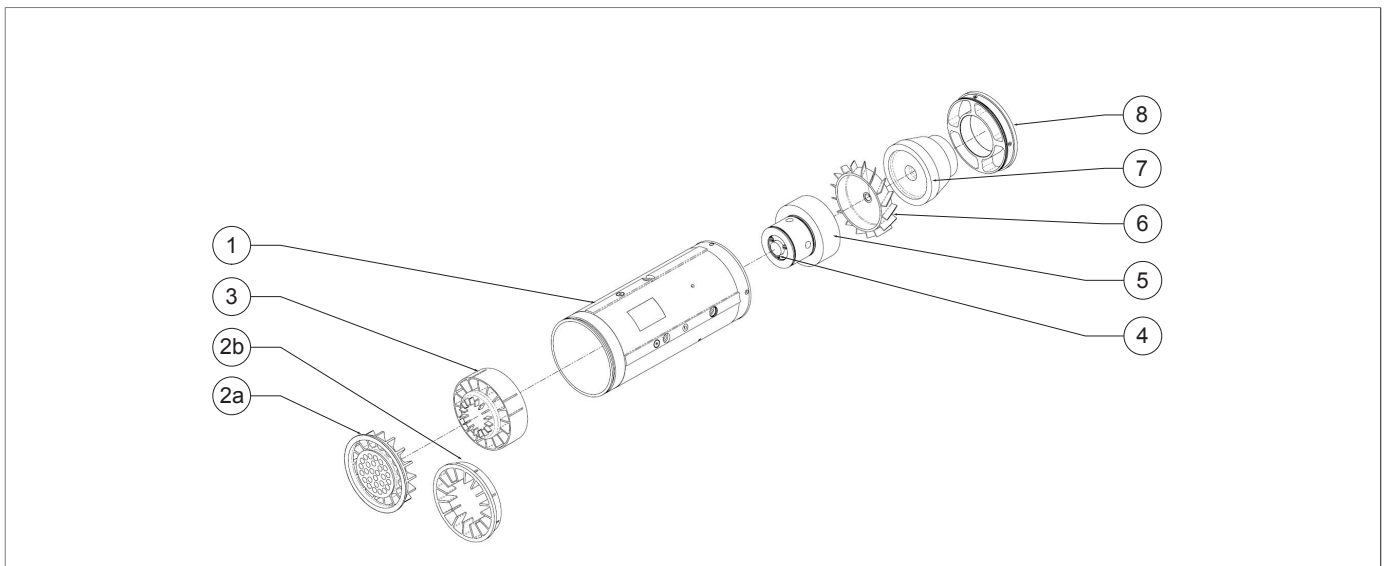

Fig. 4.3. Measuring cartridge unit

4.1.2 - TOTALISER UNIT

The totaliser unit (A) is attached to the upper part of the iM-TM meter (B) via a hybrid connector with a magnetic coupling (C-D), which enables the transmission of motion between the turbine and the totaliser unit.

The totaliser unit (A) has an IP67 protection rating.

Magnetic coupling allows:

- an adjustable orientation of 355°;
- removal/installation with just 'one turn and one click';
- the operation of the odometer on the mechanical indicator (E).

The gas quantity (expressed in m³), measured by the totaliser unit (A), is visible on the 8-digit mechanical indicator (E), which cannot be reset to one, two or no decimal places.

A metrological seal (F) is placed to guarantee the immovability of the pulse generator.



Fig. 4.4. Totaliser unit

4.1.3 - METROLOGICAL SEALS

The iM-TM meter is fitted with metrological seals.

! NOTICE!

Removing the metrological seals voids the calibration.

! NOTICE!

The following tables and figures are indicative and are intended only to show the position of the metrological seals.

The metrological seals applied are listed in Table 4.15 (any additional seals applied to the meter are not metrological):

Pos.	Description
1	Pulse emitter seal and metrological plate (if present).
2	Seal of the metrological plate on the turbine meter body.
3	Totaliser seal.

Tab. 4.15.

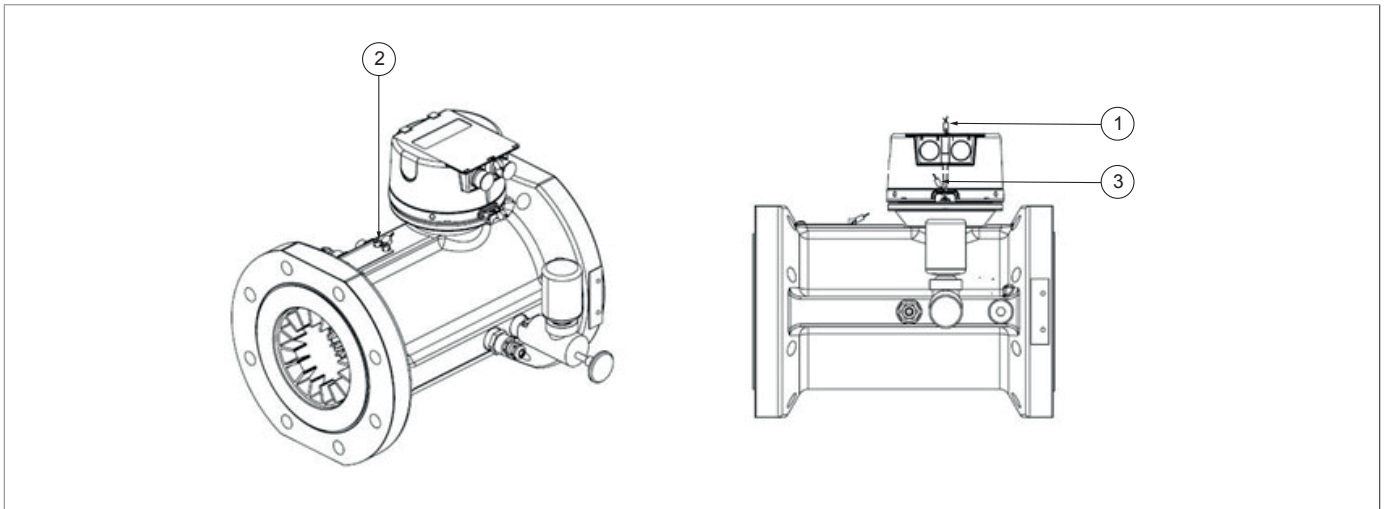

Fig. 4.5. Placement of metrological seals

! NOTICE!

The meter plate can be:

- on the body and protected with the seal in pos. 2;
- on the top of the totalising unit and protected with the seal in pos. 1.

4.2 - ACCESSORIES

NOTICE!

Accessories can be installed:

- directly in factory;
- later, in the field.

Turbine meters iM-TM can be equipped with the following accessories:

- optical encoder indicator for applications requiring serial communication;
- High-frequency sensors.

4.2.1 - HIGH FREQUENCY SENSOR

NOTICE!

To install HF sensors, the meter must be depressurised.

NOTICE!

The sensors can also be installed into the meter at a later time without having to remove the meter or the cartridge from the installation.

Turbine meters can be provided with a High Frequency (HF) sensor.

The sensors:

- are designed and approved in accordance with the ATEX Directive;
- generate an output signal according to EN 60947 5 6/NAMUR.

The main sensors are listed in Table 4.16:

Pos.	Description	Pos.	Description
1	HF on the main shaft	2	HF on turbine wheel

Tab. 4.16.

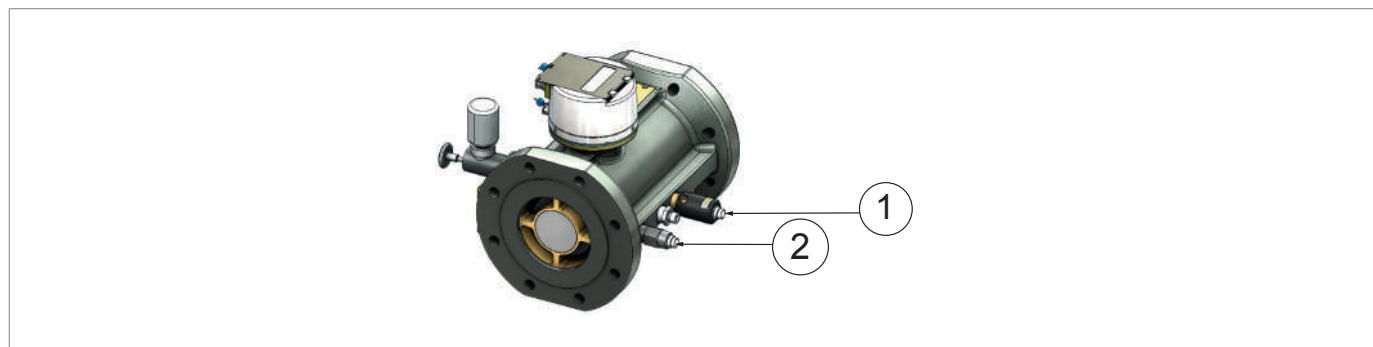

Fig. 4.6. HF sensor locations

4.3 - INTENDED USE

4.3.1 - ENVISAGED USE

The equipment in question is intended for:

Operation	Permitted	Unpermitted	Work environment
Measurement of the volume of:	Gaseous, non-aggressive or corrosive, dry and pre-filtered fluids: <ul style="list-style-type: none"> • natural gas; • argon; • butane; • ethane; • nitrogen; • carbon monoxide; • carbon dioxide; • air; • methane; • biomethane with up to 25% hydrogen blends • pentane; • propane. 	<ul style="list-style-type: none"> • Liquids. • Any other type of gas other than permitted. 	<ul style="list-style-type: none"> • high-pressure transmission systems; • electric power plants; • heavy industry; • medium-low pressure natural gas distribution networks.

Tab. 4.17.

The equipment in question is designed to be used:

- only within the limits indicated on the nameplate;
- according to the instructions and limits of use given in this manual.

Safe work indications are:

- use within the limits stated on the nameplate and in this manual;
- compliance with the procedures in the manual;
- routine maintenance to be carried out when and how recommended;
- extraordinary maintenance to be carried out if required;
- do not tamper with and/or bypass the safety devices.

4.3.2 - REASONABLY FORESEEABLE MISUSE

Incorrect and reasonably foreseeable use means the use of the equipment in a way not foreseen in the phase but which can derive from easily foreseeable human behaviour:

- use of the equipment other than as provided for in section 4.3.1 ("Intended use");
- use of the equipment with corrosive/aggressive fluids;
- use of the equipment with fluids that have not been properly treated upstream;
- use of the equipment with liquids;
- use of the equipment as a spacer when welding pipes;
- instinctive reaction of an operator in the event of a malfunction, accident or breakdown while using the equipment;
- behaviour resulting from pressure to keep the equipment running under all circumstances;
- behaviour resulting from carelessness;
- behaviour resulting from the use of the equipment by unauthorised and unsuitable people (children, disabled);
- use the equipment outside the prescribed limits;

Any use of the equipment other than the intended use must be previously approved in writing by PIETRO FIORENTINI S.p.A. If no written approval is provided, use shall be considered improper.

In the event of "improper use", PIETRO FIORENTINI S.p.A. shall not be held liable for any damage caused to people or property, and any type of warranty on the equipment shall be deemed void.

4.4 - TECHNICAL FEATURES/PERFORMANCE

NOTICE!

Bodies:

- of aluminium up to 8" can operate with a Pmax of up to 20 bar;
- of steel up to 12" can operate with a Pmax of up to 100 bar depending on the type of flange required.

The main specifications of the iM-TM series are:

Technical features	
Flow rates	from 5 m ³ /h to 6500 m ³ /h (from 176.5 cfm to 229545 cfm)
Design pressure (PS)	up to 10 MPa (up to 100 barg)
Room temperature	-40 °C to +70 °C (-40 °F to +158 °F)
Gas temperature	-25 °C to +65 °C (-13 °F to +149 °F)
Accuracy	$Q_{min} \leq Q < Q_t \pm 2\%$ and $Q_t \leq Q \leq Q_{max} \pm 1\%$ (Q_t according to EN12261)
Accuracy class	1.0
Range	up to 1:20
Repeatability	better than 0.1%
Protection rating	IP 67
Applicable metrology standards	MID 2014/32/EU
Mechanical environmental class	M1
Electromagnetic environmental class	E2
Index & pulse out	<ul style="list-style-type: none"> • 8 digits. • 2x low frequency pulse out (NO reed contact). • 1x anti-fraud output (NC reed contact).
Hazardous area certification	ATEX II 2 G Ex h IIB T6 Gb
Accessories	<ul style="list-style-type: none"> • Optical encoder indicator. • High-frequency sensors.
Nominal dimensions DN	<ul style="list-style-type: none"> • Aluminium body: from DN 50 to DN 200. • Carbon steel body: from DN 50 to DN 300.
Connections	<ul style="list-style-type: none"> • Flange class 150/300/600 according to ASME B16.5. • PN 16 to PN 100 according to EN 1092-1.
Pressure and temperature connections	1/4" NPT fem.

Tab. 4.18.

NOTICE!

Stated temperature ranges are the maximum for which the equipment's full performance, including accuracy, are fulfilled. Standard product may have a narrower range.

4.5 - POSSIBLE CONFIGURATIONS AND OPERATING CONDITIONS

iM-TM turbine meters product line extends from G40 through G4000.

The models in the iM-TM series are available in versions:

- Q (quantometers) with aluminium body.
- CT (Custody Transfer) with aluminium body
- CT (Custody Transfer) with steel body.

We list in Tab. 4.19., Tab. 4.20 and Tab. 4.21 the operating conditions of available models:

Operating conditions - Quantometers (aluminium body)						
Model	Qmax	Qmin	Field	DN	PN	Pulses at low frequency
	m ³ /h	m ³ /h	max			Imp./m ³
G40	65	13	1:5	50	PN 16 or ANSI 150	10
G65	100	10	1:10			1
G100	160	16	1:10			
G100	160	16	1:10	80	PN 16 or ANSI 150	1
G160	250	25	1:10			
G250	400	20	1:20			
G400	650	32	1:20			
G160	250	25	1:10	100	PN 16 or ANSI 150	1
G250	400	20	1:20			
G400	650	32	1:20			
G650	1000	50	1:20			

Tab. 4.19.

Operating conditions - Custody transfer (aluminium body)						
Model	Q _{max}	Q _{min}	Field	DN	PN	Pulses at low frequency
	m ³ /h	m ³ /h	max			Imp./m ³
G65	100	5	1:20	50	PN 16 or ANSI 150	10
G100	160	8	1:20			1
G100	160	8	1:20	80	PN 16 or ANSI 150	1
G160	250	13	1:20			
G250	400	20	1:20			
G400	650	32	1:20			
G160	250	13	1:20	100	PN 16 or ANSI 150	1
G250	400	20	1:20			
G400	650	32	1:20			
G650	1000	50	1:20			
G400	650	32	1:20	150	PN 16 or ANSI 150	1
G650	1000	50	1:20			0.1
G1000	1600	80	1:20			
G1600	2500	130	1:20			
G650	1000	50	1:20	200	PN 16 or ANSI 150	1
G1000	1600	80	1:20			0.1
G1600	2500	130	1:20			
G2500	4000	200	1:20			

Tab. 4.20.

Operating conditions - custody transfer (steel body)

Model	Qmax	Qmin	Field	DN	PN	Pulses at low frequency
	m ³ /h	m ³ /h	max			Imp./m ³
G65	100	5	1:20	50	PN16, ANSI150, ANSI300 or ANSI600	10
G100	160	8	1:20			1
G100	160	8	1:20	80	PN16, ANSI150, ANSI300 or ANSI600	1
G160	250	13	1:20			
G250	400	20	1:20			
G400	650	32	1:20			
G160	250	13	1:20	100	PN16, ANSI150, ANSI300 or ANSI600	1
G250	400	20	1:20			
G400	650	32	1:20			
G650	1000	50	1:20			
G400	650	32	1:20	150	PN16, ANSI150, ANSI300 or ANSI600	1
G650	1000	50	1:20			0.1
G1000	1600	80	1:20			
G1600	2500	130	1:20			
G650	1000	50	1:20	200	PN16, ANSI150, ANSI300 or ANSI600	1
G1000	1600	80	1:20			0.1
G1600	2500	130	1:20			
G1000	1600	80	1:20	250	PN16, ANSI150, ANSI300 or ANSI600	0.1
G1600	2500	130	1:20			
G2500	4000	200	1:20			
G1600	2500	130	1:20	300	PN16, ANSI150, ANSI300 or ANSI600	0.1
G2500	4000	200	1:20			
G4000	6500	320	1:20			

Tab. 4.21.

4.6 - OIL REFRESHING & FLUSHING LUBRICATION SYSTEM

The precision bearings of turbine meters iM-TM must be kept clean and lubricated.

The effective removal of dirt and dust from the bearings and gears together with the oil change optimises the accuracy of the turbine meter, especially in low-grade gas applications.

The turbine meters iM-TM incorporate a lubrication system of:

- oil replacement;
- oil washing;

to lubricate bearings, gears and shafts during operation and direct dirty oil away from critical parts.

Depending on the model and pressure rating of the meters, three different lubrication systems are provided:

Pump code	Description	Use
0010-7999-0101	Piston pump for low pressures (cyclic capacity 1 cm ³)	Meters with aluminium and steel housing DN ≤ 8" PN16 or ANSI150
0010-7100-0111	Hand lever pump for medium pressures (cyclic capacity 1 cm ³)	Meters with steel housing with nominal pressures ≤ 50 barg
0010-7100-0112	Hand lever pump for high pressures (cyclic capacity 0.5 cm ³)	Meters with steel housing with nominal pressures ≤ 100 barg

Tab. 4.22.

NOTICE!

Refer to Chapter 6 and Chapter 9 for lubrication and oil change procedures.

PAGE INTENTIONALLY LEFT BLANK

5 - TRANSPORT AND HANDLING





5.1 - SPECIFIC WARNINGS FOR TRANSPORT AND HANDLING

NOTICE!

Transport and handling must be carried out in compliance with the regulations in force in the country of installation by personnel who are:

- qualified (specially trained);
- who are familiar with accident prevention and workplace safety regulations;
- authorised to use lifting equipment.

Transport and handling

Operator qualification	<ul style="list-style-type: none"> • Person in charge of transport, handling, unloading and placing on site. • Installer.
PPE required	<div style="display: flex; align-items: center;">     </div> <div style="background-color: #f4a460; padding: 5px; margin-top: 5px;">  WARNING! </div> <p>The PPE listed in this table is related to the risk associated with the equipment. For the PPE required to protect against risks associated with the workplace, installation or operating conditions, please refer to:</p> <ul style="list-style-type: none"> • the regulations in force in the country of installation; • <u>any information provided by the Safety Manager at the installation facility.</u>
Weights and dimensions of the equipment	For dimensions and weights please refer to sections 5.3 and 5.4.

Tab. 5.23.

5.2 - PACKAGING AND FASTENERS USED FOR TRANSPORT

The transport packaging is designed and manufactured to avoid damage during normal transport, storage and handling. The equipment must be kept in the packaging until installation.

Upon receiving the equipment, please:

- make sure that no part has been damaged during transport and/or handling;
- immediately report any damage to PIETRO FIORENTINI S.p.A..

ATTENTION!

The packaging features information in the form of either words and/or symbols to ensure correct handling.

NOTICE!

PIETRO FIORENTINI S.p.A. shall not be liable for any damage to people or property caused by accidents due to failure to comply with the instructions provided in this manual.

Tab. 5.24. describes the types of packaging used:

Ref.	Type of packaging	Image
A	Cardboard boxes on pallets.	
B	Single cardboard box on pallet.	
C	Single wooden crate prepared for forklift handling.	

Tab. 5.24.

5.2.1 - PACKAGING CONTENT

The packaging contains:

Description of content

- iM-TM meter;
- bottle of oil sufficient for first lubrication (if necessary);
- 6-pole connector for LF impulse emitter;
- calibration certificate
- leak test certificate;
- EU Declaration of Conformity;
- user, maintenance and warning manual.

Tab. 5.25.

NOTICE!

On specific request, the packaging may contain:

- **material certificates (according to EN 10204);**
- **conical or flat filter;**
- **gaskets and flange hardware;**
- **1- or 3-metre pre-wired cable for LF or HF emitter;**
- **fittings.**

NOTICE!

The iM-TM meter is then shipped without lubrication oil in the tanks.

NOTICE!

**The use, maintenance and warning manual can also be downloaded from the Manufacturer's website:
<https://www.fiorentini.com>**

5.3 - PHYSICAL CHARACTERISTICS IM-TM (ALUMINIUM BODY)

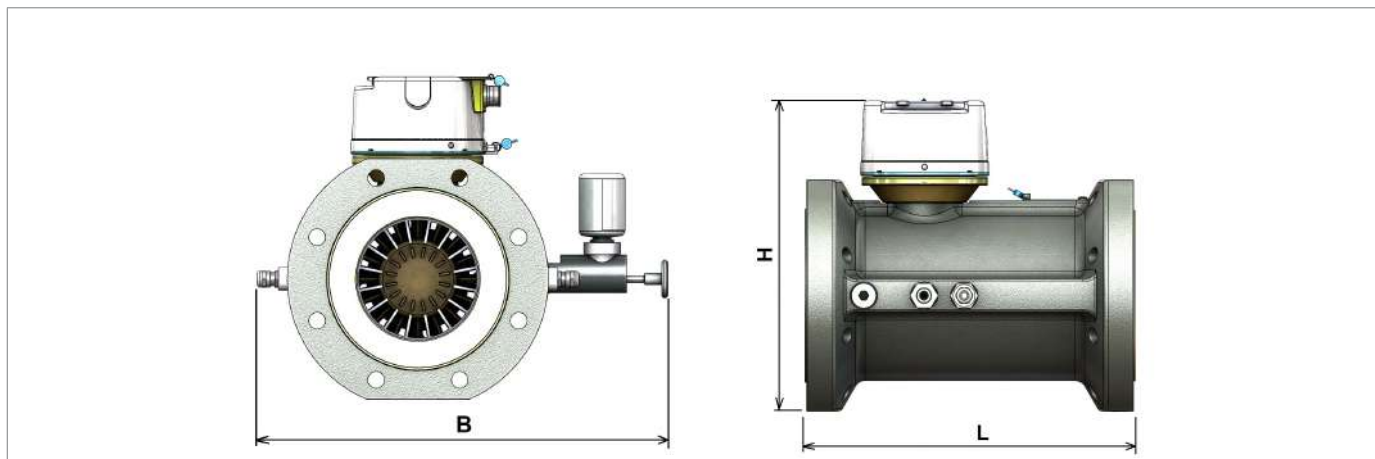

Fig. 5.7. Physical characteristics iM-TM aluminium body

Weights and dimensions - Q version

DN	Class		L ± 5 mm	B ± 10 mm	H ± 10 mm	Weight
-	PN	ANSI	mm	mm	mm	kg
50	16	150	150	307	240	5.5
80	16	150	120	330	270	6.8
100	16	150	150	360	300	8.2

Tab. 5.26.

Weights and dimensions - CT version

DN	Class		L ± 5 mm	B ± 10 mm	H ± 10 mm	Weight
-	PN	ANSI	mm	mm	mm	kg
50	16	150	150	307	240	5.5
80	16	150	240	330	270	12
100	16	150	300	360	300	15
150	16	150	450	410	360	30
200	16	150	600	470	390	57

Tab. 5.27.

5.4 - PHYSICAL CHARACTERISTICS IM-TM (STEEL BODY)

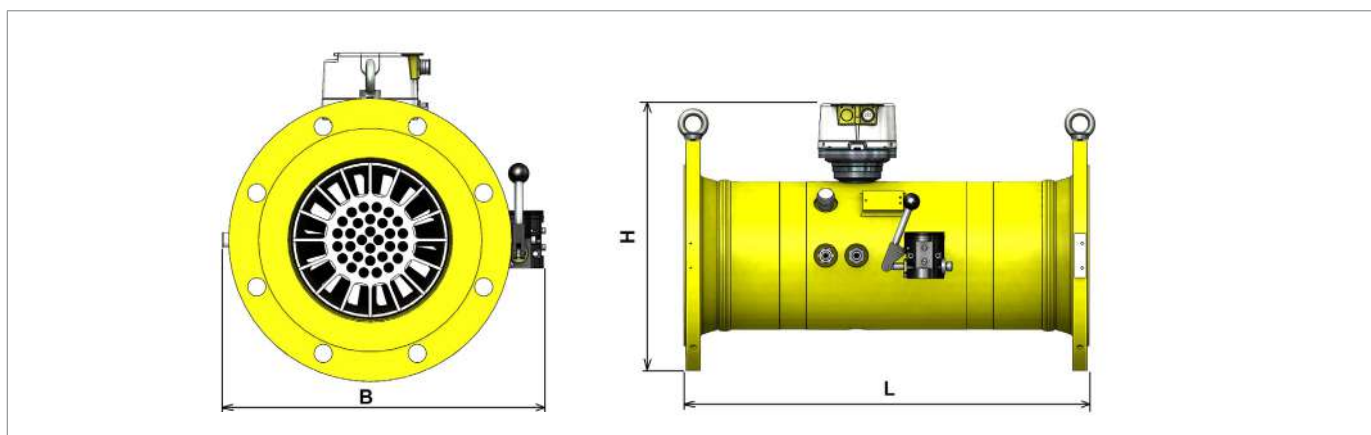

Fig. 5.8. Physical characteristics iM-TM steel body

Weights and dimensions - CT version						
DN	Class		L ± 5 mm mm	B ± 10 mm mm	H ± 10 mm mm	Weight kg
	PN	ANSI				
50	16	150	150	310	250	20
	64	300			260	
	100	600			260	
80	16	150	240	330	260	30
	64	300			300	41
	100	600			300	43
100	16	150	300	360	285	49
	64	300		345	315	52
	100	600		420	330	55
150	16	150	450	410	350	82
	64	300		410	375	95
	100	600		440	390	112
200	16	150	600	380	395	88
	64	300		400	420	113
	100	600		420	440	160
250	16	150	750	445	455	138
	64	300		470	480	172
	100	600		510	510	245
300	16	150	900	500	515	180
	64	300		530	540	300
	100	600		560	560	328

Tab. 5.28.

5.5 - EQUIPMENT ANCHORING AND LIFTING METHOD

HAZARD!

Using lifting equipment (if necessary) for unloading, carrying and handling packages is reserved only for skilled operators who have been properly trained (and are appropriately qualified if required by the regulations in force in the country of installation) and are familiar with:

- accident prevention rules;
- workplace safety provisions;
- lifting equipment features and limits.

HAZARD!

Before handling a load, make sure that its weight does not exceed the load capacity of the lifting equipment (and any other lifting tools) specified on the specific plate.

HAZARD!

- The eyebolts provided must only be used to lift the meter without additional loads.
- The lifting point is dimensioned to lift only the equipment and not other parts of the installation connected to it.

ATTENTION!

Before handling the packaging:

- remove any movable or hanging component or firmly secure it to the load;
- protect fragile equipment;
- check that the load is stable;
- make sure to have perfect visibility along the route.

ATTENTION!

Do not use the totaliser unit to lift and/or handle the meter.

ATTENTION!

The packaging features information in the form of either words and/or symbols to ensure correct handling.

NOTICE!

When handling the meter, the lubrication tanks must be free of lubricating oil.

5.5.1 - HANDLING WITH FORKLIFT TRUCK

HAZARD!

It is forbidden to:





- Do not transit under suspended loads;
- Do not move the load over the personnel operating in the site/plant area.

WARNING!

The following is not allowed on forklifts:

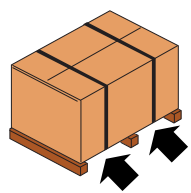
- carrying passengers;
- lifting people.

If cardboard boxes (single or multiple) are carried on a pallet, proceed as indicated in Tab. 5.29:

Step	Action	Image
1	<p>Place the forks of the forklift under the load surface.</p> <p>ATTENTION! Always use both forks and maintain a distance between them of at least 50 cm.</p>	<p>1</p> 
2	<p>Make sure that the forks protrude from the front of the load (by at least 5 cm), far enough to eliminate any risk of the transported load tipping.</p>	<p>2</p> 
3	<p>Raise the forks until they are touching the load.</p> <p>NOTICE! Fasten the load to the forks with clamps or similar devices if required.</p>	<p>3</p> 
4	<p>Slowly lift the load by a few dozen centimetres and check its stability, making sure that the centre of gravity of the load is at the centre of the lifting forks.</p>	<p>4</p> 

Step	Action	Image
5	Tilt the mast backwards (towards the driver's seat) to help the over-turning moment and to ensure greater load stability during transport.	
6	Adjust transport speed according to the type of floor and load, avoiding sudden manoeuvres. ⚠ WARNING! In case of: <ul style="list-style-type: none"> • obstacles along the route; • particular operating situations; hindered operator visibility, the assistance of a ground operator is required, standing outside the range of action of the lifting equipment, with the task of signalling.	-
7	Place the load in the chosen installation/storage area.	-

Tab. 5.29.

5.5.2 - CRANE HANDLING

HAZARD!

Before handling the equipment, make sure that:

- the rope or chain intended for lifting has a maximum working load that exceeds the weight to be handled;
- the eyebolts are tightened.

HAZARD!

It is forbidden to:

- Do not transit under suspended loads;
- handling the equipment above the personnel working in the site/establishment area;
- use bars, handles or keys to tighten the eyebolts;
- use a single eyebolt to lift a load that is unsteady or free to rotate;
- feed the slings through the eyebolts or chains mounted on pairs of eyebolts;
- force hooks or other accessories into the eyebolts. The hooks must fit loosely;
- subject the eyebolts to impacts.

The equipment must be handled using the lifting points provided on the equipment itself. Proceed as shown in tab.5.30:

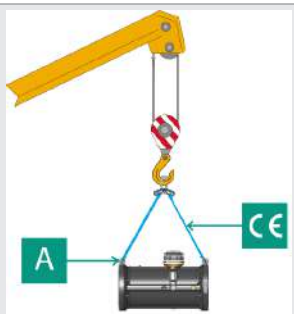
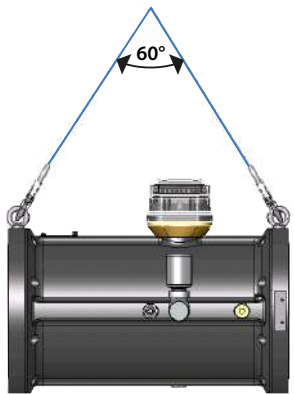
Step	Action	Image
1	Remove packaging (when necessary).	
2	Attach the lifting rope or chain to the lifting eyebolts (A) on the equipment. <div style="border: 1px solid blue; padding: 5px; margin-top: 10px;">  NOTICE! Mandatory use: <ul style="list-style-type: none"> • CE-marked chains, ropes and eyebolts; • all lifting eyebolts present. </div>	
3	Lift the equipment slightly, ensuring that: <ul style="list-style-type: none"> • the angle formed by the rope/chain for lifting does not exceed 60°; • the load is correctly balanced and the centre of gravity is centred. 	
4	Slowly lift the equipment while holding it horizontally.	
5	Place the load in the chosen installation/storage area.	-

Tab. 5.30.

5.6 - PACKAGING REMOVAL

Installation	
Operator qualification	<ul style="list-style-type: none"> Installer.
PPE required	<div style="display: flex; align-items: center;">  </div> <div style="background-color: #f4a460; padding: 5px; margin-top: 5px;"> ⚠ WARNING! </div> <p>The PPE listed in this table is related to the risk associated with the equipment. For the PPE required to protect against risks associated with the workplace, installation or operating conditions, please refer to:</p> <ul style="list-style-type: none"> the regulations in force in the country of installation; <u>any information provided by the Safety Manager at the installation facility.</u>
Necessary equipment	Refer to Chapter 7 'Commissioning/maintenance equipment'.

Tab. 5.31.

To unpack the equipment in a cardboard box, proceed as specified in Tab.5.32:

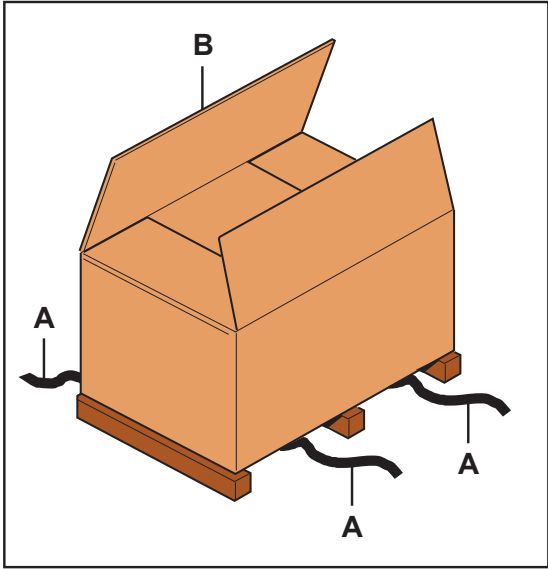
Step	Action	Image
1	Cut the straps (A).	
	Remove the adhesive tape placed at the top of the cardboard box.	
	<div style="border: 1px solid #0070c0; padding: 5px;"> ! NOTICE! If the adhesive tape is cut, take care that the blade used does not cut into the contents of the box. </div>	
2	Remove the packaging cardboard (B).	
3	Remove the fasteners that secure the equipment to the base (if any).	
4	Move the equipment from the carton to its designated place. <div style="border: 1px solid #0070c0; padding: 5px; margin-top: 5px;"> ! NOTICE! For manual handling of packages: <ul style="list-style-type: none"> adopt correct posture; if their size/weight requires it, employ at least 2 operators. </div>	

Tab. 5.32.

To unpack the equipment in a wooden crate, proceed as specified in Tab.5.33:

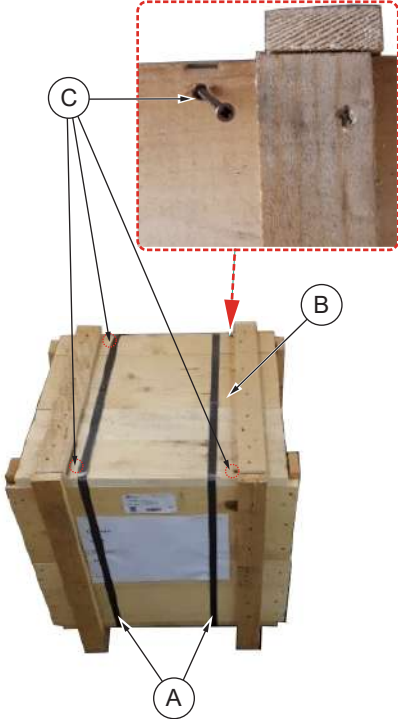
Step	Action	Image
1	Cut the straps (A).	
2	Unscrew the screws (C) near the edges that secure the cover (B) of the crate.	
3	Remove the cover (B) of the crate.	
4	Move the equipment from the crate to its designated place. <div style="border: 1px solid blue; padding: 5px; margin-top: 10px;"> <p>NOTICE!</p> <p>For manual handling of packages:</p> <ul style="list-style-type: none"> adopt correct posture; if their size/weight requires it, employ at least 2 operators. </div>	

Tab. 5.33.

NOTICE!

After removing all packaging materials, check for any anomalies.
 If there are anomalies:

- do not install the equipment;
- contact PIETRO FIORENTINI S.p.A. and specify the details provided on the equipment nameplate.

WARNING!

The individual equipment is contained in specially designed packaging. Avoid unpacking the equipment before installation.

5.6.1 - PACKAGING DISPOSAL

NOTICE!

Sort the various materials making up the packaging and dispose of them in compliance with the regulations in force in the country of installation.

5.7 - STORAGE AND ENVIRONMENTAL CONDITIONS

WARNING!

Protect the meter and flanges from blows and shocks, even accidental ones, until installation.

NOTICE!

- The meters must be stored inside their packaging in their original position (according to the indications on the packaging).
- Where no limits are indicated, stack a maximum of 2 packages.

NOTICE!

During storage:

- it is recommended to keep the meter in a horizontal position;
- meter lubrication tanks must be free of lubricating oil.

If the equipment needs to be stored for an extended period, the minimum environmental conditions for the intended storage are provided in Tab.5.34. Compliance with these conditions will guarantee the declared performance:

Conditions	Data
Maximum storage period	Maximum 6 years.
Storage temperature	from -10°C to + 25°C
Relative humidity storage environment	Less than 65% in non-condensing atmosphere.
Radiation and light sources	Away from radiation and light sources according to UNI ISO 2230:2009

Tab. 5.34.

5.7.1 - STORAGE LASTING LONGER THAN THE MAXIMUM TIME ALLOWED

NOTICE!

After a storage period exceeding the maximum permitted (6 years), contact PIETRO FIORENTINI S.p.A.

6 - INSTALLATION

6.1 - SPECIFIC SAFETY WARNINGS

WARNING!

The installation must be performed by qualified personnel, in compliance with the provisions in force concerning safety.

WARNING!

It is strictly forbidden to make any modifications to the equipment.

WARNING!

Installation may also take place in areas where there is a risk of explosion, which implies that all necessary prevention and protection measures have to be taken.

For these measures, please refer to the regulations in force at the place of installation.

WARNING!

Near the equipment, do not:

- use open flames (e.g. for welding operations);
- smoke.

ATTENTION!

PIETRO FIORENTINI S.p.A. is not liable for damage caused by incorrect installation of the equipment and/or otherwise different from that indicated in this manual.

6.2 - INSTALLATION PRE-REQUISITES

6.2.1 - ALLOWED ENVIRONMENTAL CONDITIONS

WARNING!

For the safe use of the equipment and its accessories, if any, observe the permissible environmental conditions and comply with the data on the identification plates (refer to section 2.8 "Applied rating plates").

WARNING!

The equipment must be installed away from atmospheric agents and direct sunlight.
Do not expose the equipment and its accessories to concentrated sunlight (e.g. through a lens).

ATTENTION!

PIETRO FIORENTINI S.p.A. is not liable for damage and/or malfunctions caused by installation in environments other than those permitted.

NOTICE!

For details of permissible environmental conditions (temperature range and classification), please refer to section 4.4 'Specifications/Performance'.

The installation site must be suitable for the safe use of the equipment.

The installation area of the equipment must be properly lit to ensure proper operator visibility during working on the equipment.

6.2.2 - STORAGE LASTING LONGER THAN THE MAXIMUM TIME ALLOWED

WARNING!

- Installing the equipment after storage exceeding the maximum admissible time (6 years) is not allowed.
- After a storage period exceeding the maximum permitted (6 years), contact PIETRO FIORENTINI S.p.A.

6.2.3 - CHECKS BEFORE INSTALLATION

HAZARD!

Please note that the T6 marking on the meter does not take into account the gas group and temperature classes of separately certified electrical devices (such as the optical encoder).

WARNING!

Before proceeding with the installation phase, make sure that:

- the line pressure does not exceed P_{max} ;
- the upstream and downstream valves installed on the line are closed and the pressure released.

WARNING!

The maximum permissible pressure (P_{max}) of turbine meters iM-TM is stated on the nameplate (refer to Section 2.8 'Applied rating plates').

Each piece of equipment is subjected to:

- resistance test (1.5 times P_{max});
- leak test (1.1 times the P_{max}).

ATTENTION!

Never use the meter as a spacer while welding.

⚠ ATTENTION!

If the installation of the equipment requires the field application of compression fittings, these must be installed in accordance with the instructions of the manufacturer of the fittings themselves.

The choice of fittings must be compatible with:

- the use specified for the equipment;
- the plant specifications when required.

⚠ ATTENTION!

Installation must not be carried out in the presence of dirt, welding residue or water in the pipes.

The pipework on the inlet side of the meter must be carefully cleaned (it is recommended to install a 160 µm filter upstream of the meter).

! NOTICE!

If a pressure regulator is installed in the vicinity of the meter, it is advisable to apply flow rectifiers with perforated discs to at least 5 DN.

Before installation, it must be ensured that:

- the intended installation space (or the place reserved for installation) meets current safety requirements and is protected from possible mechanical damage, away from heat sources or open flames, in a dry place and protected from external agents;
- there are no obstructions that could hinder installation operations or subsequent maintenance operations;
- the flow direction is respected as indicated on the nameplate (see section 2.8 of the manual). If the flow direction is incorrect, the meter must be replaced with one with the right flow direction;
- at least one shut-off valve is installed upstream;
- the meter is intact in all its parts/components and has not been damaged during handling;
- the upstream and downstream pipes are at the same level and able to bear the weight of the meter;
- the pipe inlet and outlet connections are parallel and clean;
- on the input and output connections are totally free of mechanical stress. The meter must be installed with no mechanical stress due to misalignment in the pipes;
- the seals are new and suitable (size and pressure rating) for the installation.

6.3 - GENERAL INFORMATION ON THE LINE

The iM-TM meter must be installed on the line with the arrow on the body pointing in the direction of gas flow.

Depending on the flow direction, the iM-TM meters can be installed in 3 different ways:

1. Horizontal installation with flow from left to right.
2. Horizontal installation with flow from right to left.
3. Vertical installation.

ATTENTION!

The meter configuration for vertical installation is only available on request.

For vertical meter installation contact PIETRO FIORENTINI S.p.A.

Refer to section 6.3.1 'Positioning of fittings and accessories' for the positioning of fittings and accessories.

6.3.1 - POSITIONING FITTINGS AND ACCESSORIES

The positions of fittings and accessories are shown in Tab. 6.35, Fig. 6.9 and Fig. 6.10.

The numeric indicator (7) can be rotated by approximately 350° for easy reading and/or to facilitate the connection of LF devices.

Pos.	Description	Pos.	Description
1	HF sensor on turbine wheel (optional)	5	HF sensor on main shaft (optional)
2	Pressure outlet (P _m)	6a	Piston oil pump (optional)
3	Thermowell	6b	Hand lever oil pump (optional).
4	LF Sensor	7	Numeric indicator

Tab. 6.35.

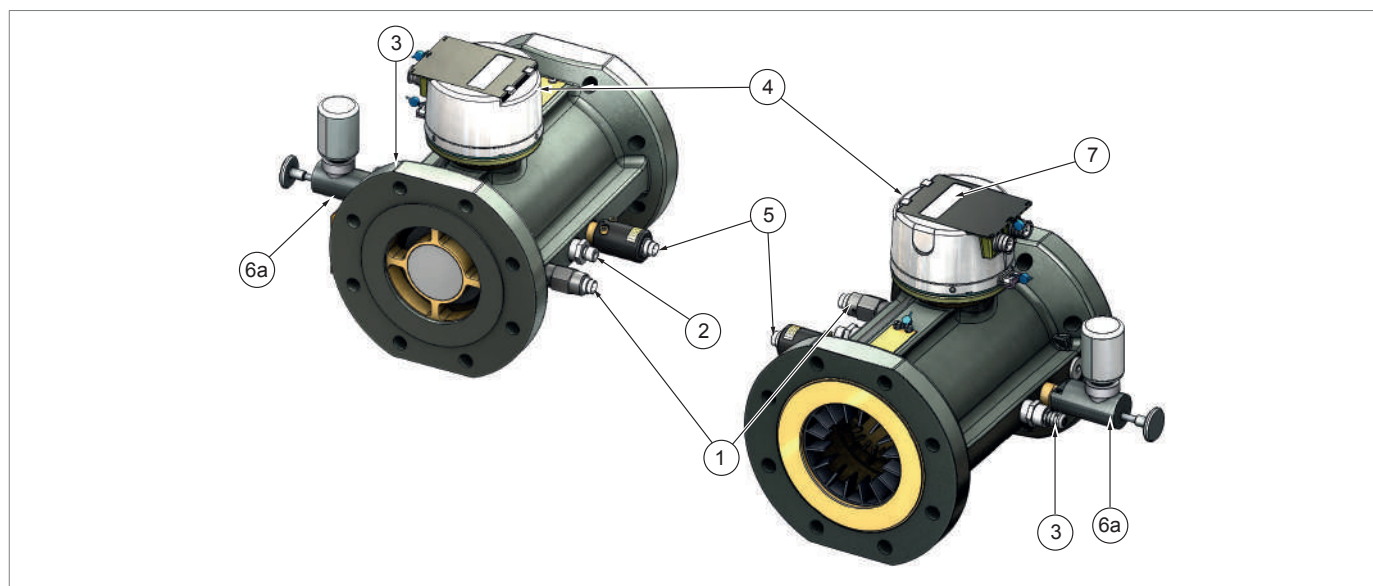

Fig. 6.9. Positioning fittings and meter accessories iM-TM aluminium body

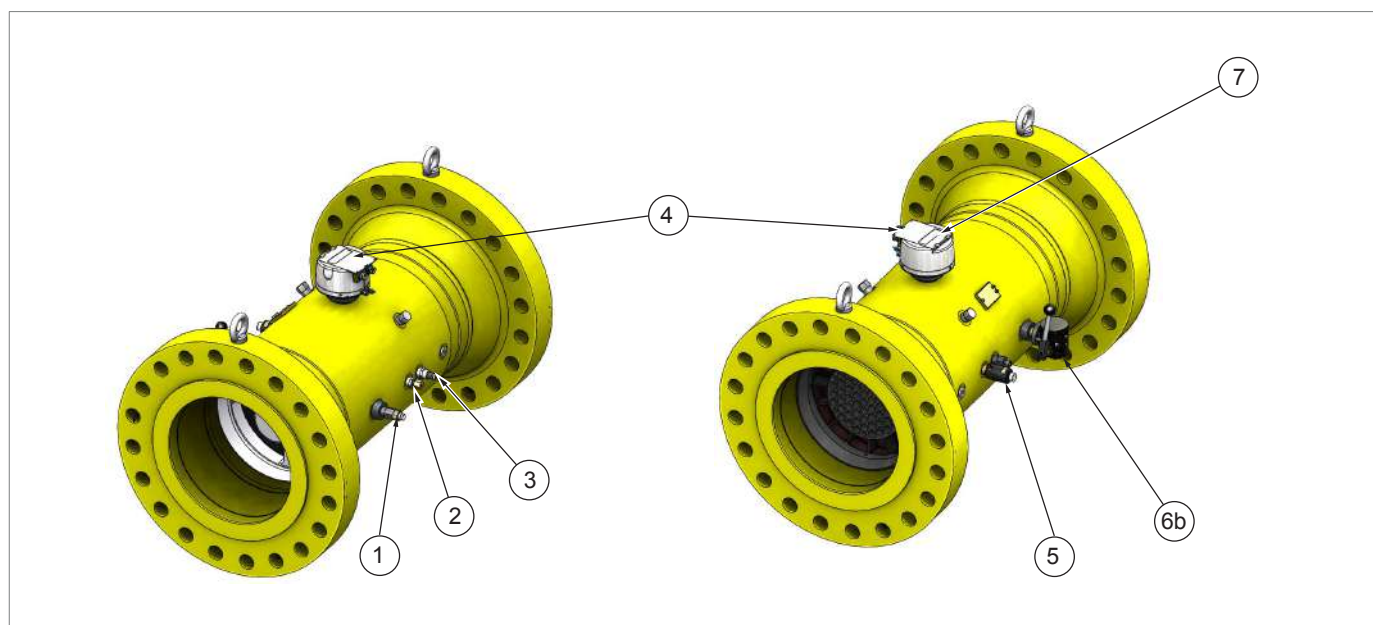



Fig. 6.10. Positioning fittings and meter accessories iM-TM steel body

6.4 - INSTALLATION PROCEDURES

Installation	
Operator qualification	<ul style="list-style-type: none"> • Installer.
PPE required	<div style="display: flex; align-items: center;">  </div> <div style="background-color: #ff8c00; padding: 5px; margin-top: 5px;"> ⚠ WARNING! </div> <p>The PPE listed in this table is related to the risk associated with the equipment. For the PPE required to protect against risks associated with the workplace, installation or operating conditions, please refer to:</p> <ul style="list-style-type: none"> • the regulations in force in the country of installation; • <u>any information provided by the Safety Manager at the installation facility.</u>
Necessary equipment	Refer to Chapter 7 'Commissioning/maintenance equipment'.

Tab. 6.36.

6.4.1 - EQUIPMENT INSTALLATION

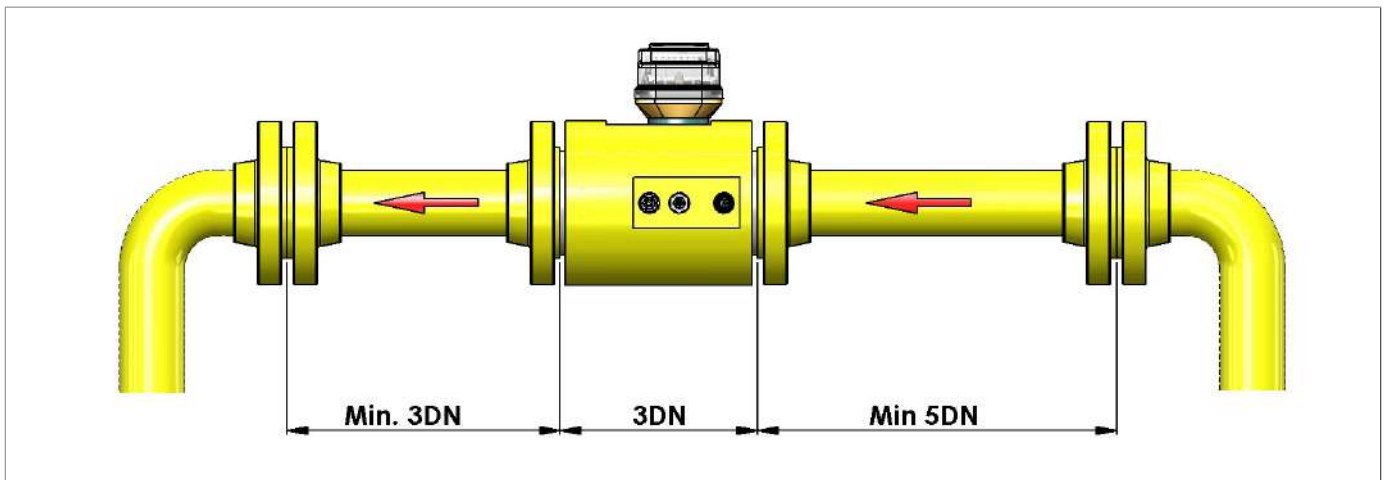

Fig. 6.11. Recommended installation iM-TM

⚠ ATTENTION!

During the installation of the meter, the oil tanks must be empty. Fill the lubricating oil tanks only after installation is complete.

⚠ ATTENTION!

- According to EN12261, the straight section upstream of the turbine meter must be at least 2 times the DN. However, to further limit flow disturbances, it is recommended to provide a straight section upstream of 5 times the DN.
- Pipes downstream of the meter may have any configuration, provided they have the same nominal diameter as the meter itself. To further limit flow disturbances, it is recommended to provide a straight downstream section of 3 times the DN.

! NOTICE!

- Ensure that the meter flanges and gaskets are clean and free of foreign material.
- Do not install the meter at the lowest point of the system, as liquids and dirt tend to accumulate at the bottom.
- The meter must be installed without suffering any mechanical stress due to misalignment in the pipes.

! NOTICE!

Do not install any lubricated valves (plug type, for example) immediately upstream of the meter, as an excess of lubricant can damage or block the turbine wheel.

To install the equipment, proceed as specified in Tab.6.37.:

Step	Action
1	<p>Apply the checks and controls of section 6.2.3 ("Checks before installation").</p> <p>! NOTICE! In order to avoid the collection of impurities and condensation in the pressure outlet pipes, it is recommended that the bore on the pipe does not have any burrs or internal residues.</p>
2	<p>Remove any packaging/protection of the equipment (adhesive covers are applied to each meter on the inlet and outlet flanges as protection from dirt, dust and water).</p> <p>! NOTICE! For proper disposal of packaging, please refer to the regulations in force in the country where the equipment is installed.</p>
3	<p>Position the equipment in the section of the line designated for it.</p> <p>! NOTICE! The orientation of the equipment within the line must correspond to the direction of gas flow.</p>
4	Place the gaskets between the line flanges and the meter flanges.
5	Level the meter horizontally by no more than 5 mm/m in both directions (flow direction and direction perpendicular to the flow).
6	<p>Insert the bolts into the appropriate holes in the connecting flanges and secure them.</p> <p>! NOTICE! See section 6.4.1.1 'Tightening torques'.</p>
7	<p>Set up the electrical connections.</p> <p>! NOTICE! See section 6.4.2 'Electrical Connections'.</p>
8	<p>Fill the oil tank.</p> <p>! NOTICE! See section 6.6 'Lubrication'.</p>

Tab. 6.37.

6.4.1.1 - TIGHTENING TORQUES

ATTENTION!

Use small parts:

- with minimum strength class 8.8 or stainless steel A2;
- ASTM A193 grade B8 or B7 for class 150 products.

ATTENTION!

On the 'p' and 'Pm' connections:



- the maximum tightening torque is 30 Nm;
- to tighten the coupling, use 2 spanners to prevent the fittings from rotating.

The maximum tightening torque for meters with an aluminium body (cross clamping) is:

- 80 Nm (with M16 or 5/8" UNC thread);
- 180 Nm (with M20 or 3/4" UNC thread).

6.4.2 - ELECTRICAL CONNECTIONS

Installation

Operator qualification	<ul style="list-style-type: none"> • Installer. • Electrical maintenance technician.
PPE required	 <div style="background-color: #f96; padding: 5px; margin-top: 10px;">  WARNING! </div> <p>The PPE listed in this table is related to the risk associated with the equipment. For the PPE required to protect against risks associated with the workplace, installation or operating conditions, please refer to:</p> <ul style="list-style-type: none"> • the regulations in force in the country of installation; • any information provided by the Safety Manager at the installation facility.
Equipment required	Refer to Chapter 7 'Commissioning/maintenance equipment'.

Tab. 6.38.

HAZARD!

Around the meter, a potentially explosive atmosphere may be present due to the presence of gases, the extent of which varies depending on the meter:

- the type of gas;
- ventilation;
- the size of the fault etc.

The classification of danger areas is the responsibility of the customer/installer.

HAZARD!

When the product is installed in an area with a potentially explosive atmosphere:

- use only intrinsically safe circuits for connections;
- Only install devices with suitable EX protection.

WARNING!

Electrical connections must only be carried out by qualified personnel with knowledge of the protection classes, standards and regulations for equipment in potentially explosive atmospheres.

Before proceeding with electrical connections, check that:

- the electrical circuits are intrinsically safe;

- the planned operations take into account the classification of the areas.

6.4.2.1 - LOW-FREQUENCY SENSOR IMPULSE OUTPUT (LF)

Only connect the output of the LF pulse generator to intrinsically safe circuits: the emitter characteristics are summarised in Tab. 6.39:

U _i	I _i	P _i	C _i	L _i
15 V	50 mA	120 mW	Negligible	Negligible
ATEX marking		II 2G Ex ib IIB T6 Gb		
Room temperature		MAX +70°C		

Tab. 6.39.

The LF pulse generator is available in different Pinout configurations, the main ones are listed below:

STANDARD CONFIGURATION OF THE P/N 0050-8100-0100 PULSEBOX PINS

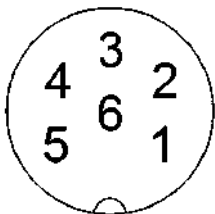

- 1 - 4 Count 1
- 2 - 5 Count 2
- 3 - 6 Anti-fraud NC

The impulse value is reported on the nameplate (e.g.: 1 imp = 1 m³)

SPECIAL CONFIGURATION OF THE P/N 0050-8100-0112 PULSEBOX PINS

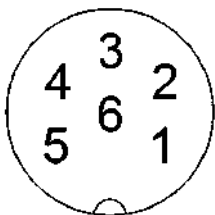

- 1 - 2 Count 1
- 5 - 6 Count 2
- 3 - 4 Anti-fraud NC

The impulse value is reported on the nameplate (e.g.: 1 imp = 1 m³)

SPECIAL CONFIGURATION OF THE P/N 0050-8100-0122 PULSEBOX PINS

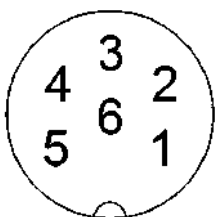

Connector I

- 4 - 6 Count 1
- 1 - 2 Antifraud NC

The impulse value is reported on the nameplate (e.g.: 1 imp = 1 m³)

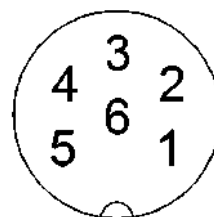

Connector II

- 3 - 5 Count 2

SPECIAL CONFIGURATION OF THE P/N 0050-8100-0125 PULSEBOX PINS

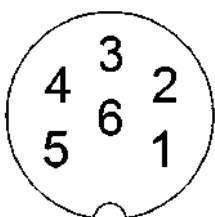

Connector I

- 1 - 4 Count 1
- 3 - 6 Anti-fraud NC

The impulse value is reported on the nameplate (e.g.: 1 imp = 1 m³)

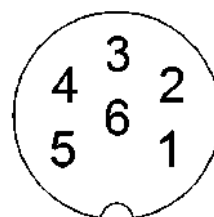

Connector II

- 2 - 5 Count 2

! NOTICE!

For the electrical features and pin configuration of the Optical Encoder series 0050-7000-04xx refer to the relevant manual TOD04107 and to the data reported on the encoder label.

6.4.2.2 - HIGH-FREQUENCY (HF) SENSOR IMPULSE OUTPUT

The 2-wire high-frequency sensor, when energised, varies the current it draws according to the energised/un-energised state.

The switching amplifier (when present), limits:

- voltage;
- the sensor current according to NAMUR EN 60947-5-6; avoiding ignition risks.

Only connect the output of the HF pulse emitter to intrinsically safe circuits: the emitter characteristics are summarised in Tab. 6.40:

Marking ATEX	Ambient temperature	U _i (Vdc)	I _i (mA)	P _i (mW)	C _i (nF)	L _i (µH)
II 1G Ex ia IIC T4 ... T6 Ga	Max +60°C	20	60 (resistively limited)	150	150	150

Tab. 6.40.

The HF pulse generator is available in one Pinout configuration:

STANDARD CONFIGURATION OF THE HIGH-FREQUENCY (HF) IMPULSE OUTPUT

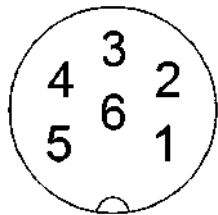

3 (-) 6 (+) Impulse output

SPECIAL HIGH FREQUENCY (HF) PULSE OUTPUT CONFIGURATION

5 (-) 6 (+) Impulse output

The impulse value is reported on the nameplate (e.g.: 1200 imp/m³)

If a preassembled cable is supplied with the connector, the pin-colour correspondence is as follows:

1. White
2. Brown
3. Green
4. Yellow
5. Grey
6. Pink

6.5 - POST-INSTALLATION INSTRUCTIONS

WARNING!

Ensure that all connections (hydraulic, mechanical and electrical) are:

- properly connected;
- tightened correctly to prevent any leakage during commissioning.

ATTENTION!

After completion of the equipment installation, a pressure test must be carried out. In the event of a leak, take appropriate measures to solve it.

6.6 - LUBRICATION



The meter comes with a bottle containing the initial amount of lubricating oil.

ATTENTION!

- The meter must not be lubricated before it is been installed.
- The injection of lubricating oil must be carried out with the lubrication pump supplied with the turbine. Other pump types must be approved by PIETRO FIORENTINI S.p.A.

NOTICE!

For filling the tanks or topping up, use only Aeroshell Fluid 12 oil supplied by PIETRO FIORENTINI S.p.A.

Lubrication	
Operator qualification	<ul style="list-style-type: none"> • Mechanical maintenance technician. • Installer. • Name of the user.
PPE required	<div style="display: flex; align-items: center;">  </div> <div style="background-color: #f96; padding: 5px; margin-top: 5px;">  WARNING! </div> <p>The PPE listed in this table is related to the risk associated with the equipment. For the PPE required to protect against risks associated with the workplace, installation or operating conditions, please refer to:</p> <ul style="list-style-type: none"> • the regulations in force in the country of installation; • <u>any information provided by the Safety Manager at the installation facility.</u>
Equipment required	Refer to Chapter 7 'Commissioning/maintenance equipment'.

Tab. 6.41.

After installation, but before commissioning, the pump oil tanks must be filled with lubricating oil.

NOTICE!

The standard oil bottle (250 ml = 250 cm³) contains more oil than required for initial installation.

6.6.1 - FILLING THE PISTON OIL PUMP TANK

NOTICE!

For filling the tanks or topping up, use only Aeroshell Fluid 12 oil supplied by PIETRO FIORENTINI S.p.A.

The quantity of oil required according to the different meter sizes is shown in Tab.6.42:

Meter size	Required amount of oil
50 mm (2")	7 cm ³
80 mm (3")	7 cm ³
100 mm (4")	7 cm ³
150 mm (6")	35 cm ³
200 mm (8")	45 cm ³

Tab. 6.42.

To fill the tanks, proceed as shown in Tab.6.43:

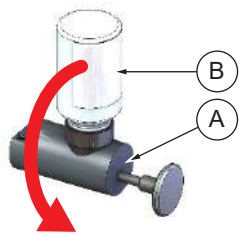
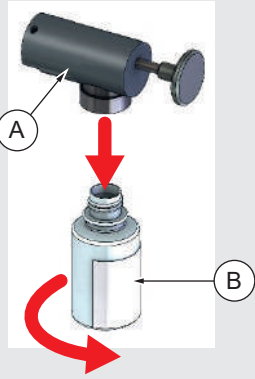
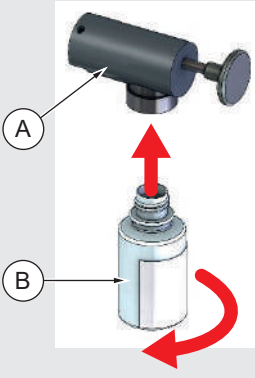
Step	Action	Image
1	Turn the oil pump (A) together with the tank (B) downwards (rest position) if necessary.	
2	Unscrew the tank (B) from the pump (A) by turning it anticlockwise.	
3	Clean and dry, if necessary, the tank (B) of the pump (A) and then pour into the tank (B) the quantity of clean oil required for lubrication (see Tab. 6.43).	
4	Screw the tank (B) to the pump (A) by turning it clockwise.	

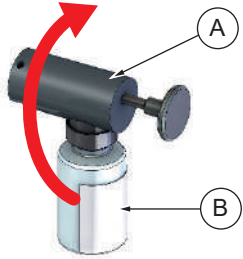
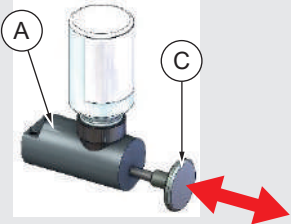
Step	Action	Image
5	Turn the oil pump (A) together with the tank (B) upwards.	
6	Inject oil from the pump (A) into the meter through the piston (C).	
7	Return the pump (A) to the home position with the tank (B) facing downwards (see Step 1).	

Tab. 6.43.

6.6.2 - FILLING THE LEVER OIL PUMP TANK

! NOTICE!

For filling the tanks or topping up, use only Aeroshell Fluid 12 oil supplied by PIETRO FIORENTINI S.p.A.

Depending on the different meter sizes, the amount of oil required and the number of lever strokes are indicated on the label attached to the pump.

To fill the tank, proceed as shown in Tab.6.44:

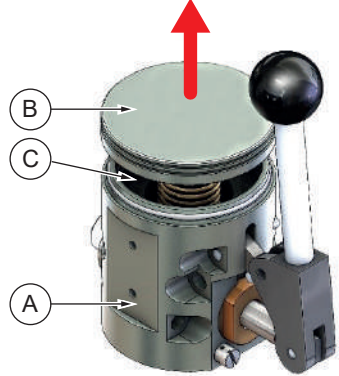
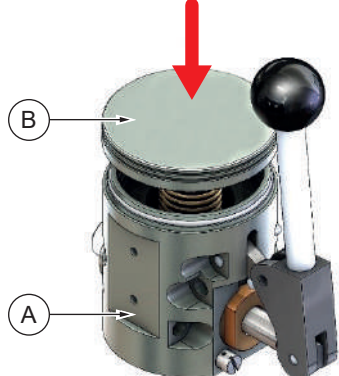
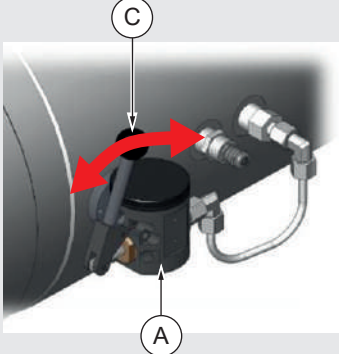
Step	Action	Image
1	Lift the cover (B) of the tank (C) of the oil pump (A).	
2	Clean and dry, if necessary, the tank (C) of the pump (A) and then pour into the tank (C) the quantity of clean oil required for lubrication (see label attached).	
3	Close the cover (B).	
4	Inject oil from the pump (A) into the meter via the lever (C) for the number of strokes indicated on the label attached.	



Tab. 6.44.

6.7 - EQUIPMENT ADJUSTMENTS

NOTICE!

All meters are calibrated according to standards at the factory PIETRO FIORENTINI S.p.A.

No further adjustments are required.

Adjustment	
Operator qualification	<ul style="list-style-type: none"> Mechanical maintenance technician. Installer. Name of the user.
PPE required	<div style="display: flex; align-items: center;">  </div> <div style="background-color: #f4a460; padding: 5px; margin-top: 5px;">  WARNING! </div> <p>The PPE listed in this table is related to the risk associated with the equipment. For the PPE required to protect against risks associated with the workplace, installation or operating conditions, please refer to:</p> <ul style="list-style-type: none"> the regulations in force in the country of installation; any information provided by the Safety Manager at the installation facility.
Equipment required	Refer to Chapter 7 'Commissioning/maintenance equipment'.

Tab. 6.45.

WARNING!

Contact PIETRO FIORENTINI S.p.A. for any further need.

Do not make any unauthorised changes to the equipment without the approval of PIETRO FIORENTINI S.p.A.

PAGE INTENTIONALLY LEFT BLANK





7 - COMMISSIONING/MAINTENANCE EQUIPMENT

7.1 - LIST OF EQUIPMENT

Use of commissioning/maintenance equipment	
Operator qualification	<ul style="list-style-type: none"> • Mechanical maintenance technician. • Electrical maintenance technician. • Installer. • Name of the user.
PPE required	<div style="display: flex; align-items: center;">  </div> <div style="background-color: #f4a460; padding: 5px; margin-top: 5px;"> <p>⚠ WARNING!</p> </div> <p>The PPE listed in this table is related to the risk associated with the equipment. For the PPE required to protect against risks associated with the workplace, installation or operating conditions, please refer to:</p> <ul style="list-style-type: none"> • the regulations in force in the country of installation; • <u>any information provided by the Safety Manager at the installation facility.</u>

Tab. 7.46.

The types of equipment required for the installation, commissioning and maintenance of the regulator are listed in Table 7.47:

Ref.	Equipment type	Image
A	Combination spanners 17 - 22 - 24 - 30 mm	
B	Allen key bent 1/4" AF.	
C	Phillips screwdriver.	
D	Slotted screwdriver.	
E	Torque wrench.	

Tab. 7.47.

PAGE INTENTIONALLY LEFT BLANK

8 - COMMISSIONING

8.1 - GENERAL WARNINGS

8.1.1 - SAFETY REQUIREMENTS FOR COMMISSIONING

HAZARD!

During commissioning the risks associated with any discharges to the atmosphere of flammable or noxious gases must be evaluated.

HAZARD!

In case of installation on distribution networks for natural gas, consider the risk associated with explosive mixtures (gas/air) being formed inside the piping, if the line is not subjected to inerting.



WARNING!

During commissioning, remove any unauthorised personnel.
The commissioning area must be marked with signs and/or boundaries.

NOTICE!

Commissioning has to be carried out by authorised and qualified personnel.

Commissioning

Operator qualification	<ul style="list-style-type: none"> • Installer. • Name of the user.
PPE required	<div style="display: flex; align-items: center;">  </div> <div style="background-color: #f96; padding: 5px; margin-top: 5px;">  WARNING! </div> <p>The PPE listed in this table is related to the risk associated with the equipment. For the PPE required to protect against risks associated with the workplace, installation or operating conditions, please refer to:</p> <ul style="list-style-type: none"> • the regulations in force in the country of installation; • any information provided by the Safety Manager at the installation facility.
Equipment required	Refer to Chapter 7 'Commissioning/maintenance equipment'.

Tab. 8.48.

8.2 - PRELIMINARY PROCEDURES FOR COMMISSIONING

HAZARD!

The iM-TM meter can be used to measure gas at high or low temperatures.
Avoid contact with the meter when in service.

WARNING!

Before commissioning, it must be ensured that:

- the conditions of use comply with the characteristics of the equipment;
- during pressurisation, the equipment has no leaks.

ATTENTION!

The meter iM-TM is designed to withstand a Qmax overload of 120% for a limited operating time (<1 hour). The overload must be gradual and without pulsations. Excessive overloading can damage the device and cause excessive wear on bearings and gears.

ATTENTION!

The iM-TM meter:

- must be considered part of the pressurised system;
- must not be used outside the limits indicated on the nameplate attached and inside this manual.

NOTICE!

During commissioning, record pressure drops at various flow rates to allow comparison of values for future measurements.

NOTICE!

Removing or damaging the metrological seals could invalidate the calibration.

Before commissioning the equipment, it is necessary to check:

- that the conditions of use are in accordance with the characteristics of the equipment;
- that all on/off valves (inlet, outlet, bypass if applicable) are closed;
- that the gas is at a temperature and pressure within the limits indicated on the nameplate attached (see section 2.8);
- that any source of ignition has been eliminated.

8.3 - METER COMMISSIONING

NOTICE!

Commissioning has to be carried out by authorised and qualified personnel.

Start-up can be carried out using two different procedures:

1. Pressurising the equipment by inserting an inert fluid (e.g. nitrogen) to avoid potentially explosive mixtures.
2. Direct insertion of gas into the pipes.

To commission the meter, proceed as described in Tab. 8.49.:

Step	Action
1	Open any bypass valve and the outlet valve downstream of the meter.
2	Partially open the meter inlet gas valve until the meter starts to run at low speed. <div style="border: 1px solid black; padding: 5px; margin-top: 10px;"> <p>NOTICE!</p> <ul style="list-style-type: none"> Pressurise the meter carefully while maintaining a pressure gradient of no more than 35 kPa/s (0.35 bar/s). You probably will need to partially close the bypass valve to start the flow of gas through the meter. </div>
3	Verify that gas flows through the meter by observing the movement of the digits on the totaliser assembly: <ul style="list-style-type: none"> if movement is present, proceed with Step 4; if the digits do not move, check that the gas flows to the meter. If the gas flows proceed with Step 5.
4	Let the meter run at low speed for a few minutes while listening for any unusual sounds or vibrations (scraping, beating, etc.). If operation is satisfactory, proceed to Step 6 .
5	If there are unusual sounds and vibrations (Step 4) or if the digits on the totalising unit do not move (Step 3): <ol style="list-style-type: none"> 1. interrupt the commissioning procedure; 2. slowly depressurise the meter; 3. safely vent the pressure; 4. check for misalignments, deformations, pipe torsions or other related problems (see Chapter 10 'Trouble-shooting'); 5. Resume, if the problem is solved, the commissioning procedure from Step 1.
6	Gradually open the inlet valve by pressurising the meter. <div style="border: 1px solid black; padding: 5px; margin-top: 10px;"> <p>NOTICE!</p> <p>Pressurise the meter carefully while maintaining a pressure gradient of no less than 35 kPa/s (0.35 bar/s).</p> </div>
7	Gradually close the bypass valve.
8	Follow the user's company procedures or current practice to check for leaks: <ul style="list-style-type: none"> of the meter; of the external surfaces; of all connections. <div style="border: 1px solid black; padding: 5px; margin-top: 10px;"> <p>NOTICE!</p> <p>Current practice envisages the use of: gas analysers, soapy water, foaming solutions or leak detector sprays for the final inspection of seals.</p> </div>

Step	Action
9	The conditions of the meter can be deduced from the pressure absorption. We recommend recording the pressure drop at various flow rates during installation. This value can be compared with a future measurement.

Tab. 8.49.

9 - MAINTENANCE AND FUNCTIONAL CHECKS

9.1 - GENERAL WARNINGS

HAZARD!

- No maintenance or inspection work is permitted while the meter is pressurised or in operation.
- Repair or maintenance work not provided for in this manual may be carried out only if approved by PIETRO FIORENTINI S.p.A.. PIETRO FIORENTINI S.p.A. shall not be held liable for damage to persons or property resulting from operations other than those described herein or carried out in ways other than as indicated.

HAZARD!

Maintenance operations:

- require extensive and specialised knowledge of the machines, operations required, risks involved and correct procedures to operate safely;
- are reserved for qualified, educated, recognised and authorised operators by PIETRO FIORENTINI S.p.A.

HAZARD!

Maintenance operators must be aware of the measures to be taken to prevent possible causes of ignition (e.g. production of sparks, electrostatic charges, etc.)

WARNING!

Before removing the meter from the line on which it is installed, depressurise the system if necessary.

WARNING!

Never carry out hydraulic tests or oil hydraulic tests.
Water or any other liquid causes damage to the meter.

WARNING!

- Always follow the operating frequencies indicated in the manual for scheduled maintenance (preventive and periodic). The time interval between interventions is to be understood as the maximum acceptable and must never be exceeded.
- Promptly check the causes of any anomalies such as excessive noise, leakage of fluids or similar and remedy them. The timely removal of any causes of anomaly or malfunction avoids further damage to the equipment and ensures operator safety.

WARNING!

In case of doubt, do not perform any work. Contact PIETRO FIORENTINI S.p.A. for the necessary clarifications.

NOTICE!

Maintenance work is strictly related to:

- the quality of the conveyed gas (impurities, humidity, gasoline, corrosive substances);
- the state of cleanliness and preservation of the pipes upstream of the meter;
- the level of reliability required of the measurement system;
- the equipment conditions of use.

9.2 - MAINTENANCE OPERATIONS

The management and/or use of the equipment includes interventions that are necessary as a result of normal use such as:

- inspections and controls;
- functional checks;
- routine maintenance;
- extraordinary maintenance.

Before starting maintenance on the equipment, it is advisable to make sure that the authorised operator has:

- original/recommended spare parts;
- the necessary equipment (see Chapter 7 'Commissioning/maintenance equipment').

The equipment maintenance operations are divided, from an operational point of view, into two main categories:

Maintenance Operations	
Routine maintenance	All those operations that the operator has to perform: <ul style="list-style-type: none"> • periodically for maintenance and operation of the equipment; • preventively to ensure proper functioning of the device over time.
Extraordinary maintenance	All those operations to be carried out by the operator as required by the equipment.

Tab. 9.50.

9.2.1 - OPERATIONS PRIOR TO MAINTENANCE

Before proceeding with maintenance operations, it must be ensured that:

- the meter is secure;
- the line on which the meter is installed is intercepted upstream and downstream;
- the line on which the meter is installed has been depressurised.

9.3 - ROUTINE MAINTENANCE

HAZARD!



It is forbidden to carry out inspections, checks and maintenance if the meter is pressurised or in operation. Before an inspection, control or maintenance, check that:

- the equipment is in a safe condition:
 1. close the downstream shut-off valve;
 2. close the upstream shut-off valve;
 3. completely discharge the line.
- the pressure upstream and downstream of the equipment is “0”.

WARNING!

In case of doubt, do not perform any work. Contact PIETRO FIORENTINI S.p.A. for the necessary clarifications.

Routine maintenance

Operator qualification	<ul style="list-style-type: none"> • Mechanical maintenance technician. • Name of the user.
PPE required	<div style="display: flex; align-items: center;">  </div> <div style="background-color: #f4a460; padding: 5px; margin-top: 5px;">  WARNING! </div> <p>The PPE listed in this table is related to the risk associated with the equipment. For the PPE required to protect against risks associated with the workplace, installation or operating conditions, please refer to:</p> <ul style="list-style-type: none"> • the regulations in force in the country of installation; • any information provided by the Safety Manager at the installation facility.
Equipment required	Refer to Chapter 7 'Commissioning/maintenance equipment'.

Tab. 9.51.

9.3.1 - PERIODICALLY CHECKING AND INSPECTING THE EQUIPMENT FOR PROPER OPERATION

Table 9.52 lists the periodic checks and inspections:

Activity description	Equipment/accessories involved	Evaluation criterion	Minimum frequency
Significant performance check*	Meter iM-TM	Pressure absorption (comparing with that recorded during installation).	Half-yearly
		Correct totalisation.	Half-yearly
Visual inspection	Meter iM-TM	No visible damage.	Half-yearly
		Absence of noise.	Half-yearly
		Tightening of connections.	Half-yearly
		Integrity of connecting cables.	Half-yearly

* These checks can be carried out remotely in the presence of a remote control system capable of sending signals/alarms when pre-set thresholds are reached.

Tab. 9.52.

9.3.2 - LUBRICATION

WARNING!

The injection of lubricating oil via the pump supplied with the meter is the only maintenance work permitted even when the meter is under pressure.

NOTICE!

- Lubricate the meter quarterly.
- Do not lubricate if the meter operates at low flow rates for extended periods (e.g. in summer).

9.3.2.1 - PISTON OIL PUMP LUBRICATION

To lubricate the meter, proceed as shown in Tab.9.53:

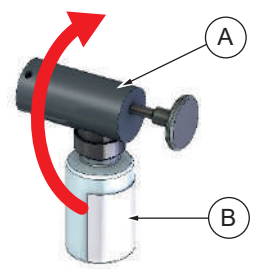
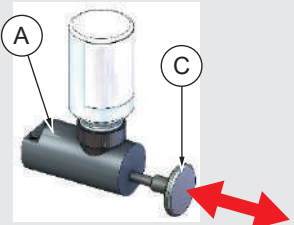
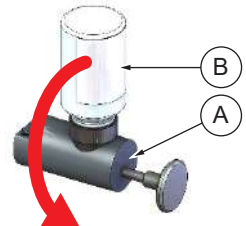
Step	Action	Image
1	Turn the oil pump (A) together with the tank (B) upwards.	
2	Inject oil from the pump (A) into the meter through the piston (C).	
3	Turn the oil pump (A) together with the tank (B) downwards into the rest position.	

Tab. 9.53.

9.3.2.2 - LEVER OIL PUMP LUBRICATION

To lubricate the meter, proceed as shown in Tab.9.54:

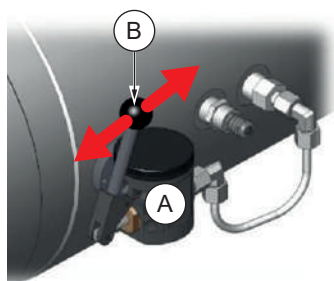
Step	Action	Image
1	Inject oil from the pump (A) into the meter via the lever (B) for the number of strokes indicated on the label attached.	

Tab. 9.54.

9.3.3 - CLEANING THE PISTON OIL PUMP TANK

! NOTICE!

The oil tank must be emptied and cleaned before and after each filling to prevent moisture from accumulating.

Oil has a tendency to collect dirt, dust and moisture, which if introduced into the meter can cause even serious failures. To clean the piston oil pump tank, proceed as shown in Tab.9.55:

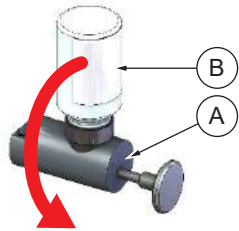
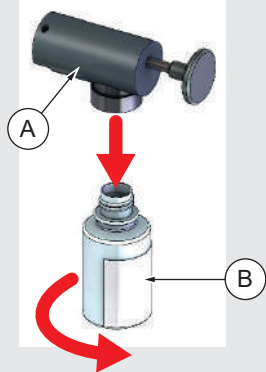
Step	Action	Image
1	Turn the oil pump (A) together with the tank (B) downwards (rest position) if necessary.	
2	Unscrew the tank (B) from the pump (A) by turning it anticlockwise.	
3	Empty the tank (B) of the pump (A) into a suitably sized container.	
<p>! NOTICE! Used oil is highly toxic and should not be disposed of with household waste under any circumstances. When disposing of used oil, strictly observe the regulations in force in the country where the equipment is installed.</p>		
4	Clean and dry the tank (B) of the pump (A).	
5	Fill the tank (B) with oil as described in section 6.6.1 "Filling the oil pump piston tank" (Steps 3 to 7).	
<p>! NOTICE! For filling the tank (B), use only Aeroshell Fluid 12 oil supplied by PIETRO FIORENTINI S.p.A.</p>		

Tab. 9.55.

9.3.4 - BLEEDING AND CLEANING THE LEVER OIL PUMP TANK

! NOTICE!

Bleed and clean the tank before and after each filling.

Oil has a tendency to collect dirt, dust and moisture, which if introduced into the meter can cause even serious failures. To bleed and clean the lever oil pump tank, proceed as shown in Tab.9.56:

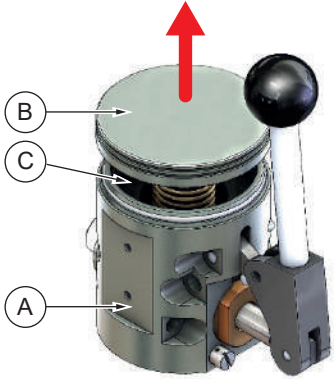
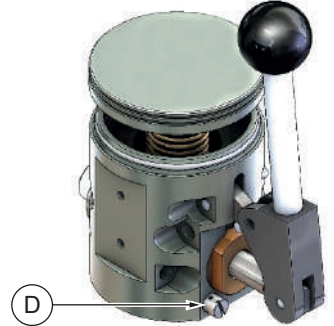
Step	Action	Image
1	Lift the cover (B) of the tank (C) of the oil pump (A).	
2	Place a suitably sized container under the bleed screw (C) to prevent oil from spilling onto the ground.	
3	Unscrew the bleed screw (D) anticlockwise and empty the tank completely, taking care that the oil falls into the container. Equipment required: slotted screwdriver.	
4	Clean and dry the tank (C) of the pump (A).	
5	Fill the tank (C) with oil as described in section 6.6.2 "Filling the lever oil pump tank" (Steps 2 to 4).	<p>! NOTICE!</p> <p>For filling the tank (C), use only Aeroshell Fluid 12 oil supplied by PIETRO FIORENTINI S.p.A.</p>

Tab. 9.56.

9.3.5 - TOPPING UP OIL

 **NOTICE!**

For topping up, use only Aeroshell Fluid 12 oil supplied by PIETRO FIORENTINI S.p.A.

Check the amount of oil in the meter periodically, at least twice a year.

Proceed as described in paragraphs:

- 6.6.1. "Filling the oil pump piston tank";
- 6.6.2. "Filling the lever oil pump tank";
- 9.3.2. "Lubrication".

9.4 - EXTRAORDINARY MAINTENANCE

HAZARD!

Extraordinary maintenance:

- requires extensive and specialised knowledge of the machines, operations required, risks involved and correct procedures to operate safely;
- is reserved for qualified, trained, recognised and authorised technicians by PIETRO FIORENTINI S.p.A.

HAZARD!



It is forbidden to carry out extraordinary maintenance operations if the meter is pressurised or in operation. Before an extraordinary maintenance operation, check that:

- the equipment is in a safe condition:
 1. close the downstream shut-off valve;
 2. close the upstream shut-off valve;
 3. completely discharge the line.
- the pressure upstream and downstream of the equipment is “0”.

WARNING!

In case of doubt, do not perform any work. Contact PIETRO FIORENTINI S.p.A. for the necessary clarifications.

Extraordinary maintenance

Operator qualification	<ul style="list-style-type: none"> • Mechanical maintenance technician. • Installer. • Name of the user.
PPE required	<div style="text-align: center;">  </div> <div style="background-color: #f4a460; padding: 5px; margin-top: 5px;">  WARNING! </div> <p>The PPE listed in this table is related to the risk associated with the equipment. For the PPE required to protect against risks associated with the workplace, installation or operating conditions, please refer to:</p> <ul style="list-style-type: none"> • the regulations in force in the country of installation; • <u>any information provided by the Safety Manager at the installation facility.</u>
Equipment required	Refer to Chapter 7 'Commissioning/maintenance equipment'.

Tab. 9.57.

9.4.1 - UNINSTALLING THE METER

To uninstall the meter, proceed as shown in Tab.9.58:

Step	Action
1	<p>Check that the meter and the piping in which it is mounted are:</p> <ul style="list-style-type: none"> depressurised; at room temperature. <div style="border: 1px solid black; padding: 5px;"> <p>! NOTICE!</p> <p>Take the necessary precautions to avoid the risks associated with the possible dispersion of residual fluid (toxic and flammable) in the pipes.</p> </div>
2	Disconnect the connection to the pulse emitters.
3	<p>Empty the oil tank as described in sections:</p> <ul style="list-style-type: none"> 9.3.3. "Cleaning the Piston Oil Pump Tank"; 9.3.4. "Bleeding and cleaning the lever oil pump tank". <div style="background-color: yellow; padding: 5px;"> <p>! ATTENTION!</p> <p>Do not touch the oil.</p> </div> <div style="border: 1px solid black; padding: 5px;"> <p>! NOTICE!</p> <p>Used oil is highly toxic and should not be disposed of with household waste under any circumstances.</p> <p>When disposing of used oil, strictly observe the regulations in force in the country where the equipment is installed.</p> </div>
4	Unscrew the bolts from the holes in the connecting flanges and remove them.
5	<p>Remove the equipment from the installation line.</p> <div style="border: 1px solid black; padding: 5px;"> <p>! NOTICE!</p> <p>For handling of the equipment, see Chapter 5 'Transport and Handling'.</p> </div>

Tab. 9.58.

! HAZARD!

At a new installation of the meter, perform a new leak test.

! WARNING!

A possible reinstallation of the meter provides for the use:

- of new gaskets/o-rings;
- appropriate mounting materials.

! NOTICE!

See chapters 6 and 8 of this manual for installation and commissioning procedures.

PAGE INTENTIONALLY LEFT BLANK

10 - TROUBLESHOOTING

Below is a list of the cases (causes and services) that may occur over time in the form of malfunctions of various kinds. These situations depend on the conditions of the gas as well as on the natural ageing and wear of the materials.

10.1 - GENERAL WARNINGS

HAZARD!

Any maintenance work following the occurrence of a fault must be carried out by personnel:

- trained on workplace safety also based on the regulations in force in the place of installation of the work equipment;
- qualified and authorised to carry out activities related to the equipment.

WARNING!



PIETRO FIORENTINI S.p.A. shall not be held liable for any damage to people and property due to services:

- other than those described;
- performed according to methods other than those specified;
- carried out by unsuitable personnel.

NOTICE!

If an operating fault occurs and qualified personnel are not available for the specific intervention, call the Assistance Centre authorised by PIETRO FIORENTINI S.p.A.

10.2 - OPERATOR QUALIFICATION SPECIFICATION

Troubleshooting	
Operator qualification	<ul style="list-style-type: none"> • Mechanical maintenance technician. • Installer. • Name of the user.
PPE required	<div style="display: flex; align-items: center;">  </div> <div style="background-color: #f4a460; padding: 5px; margin-top: 5px;">  WARNING! </div> <p>The PPE listed in this table is related to the risk associated with the equipment. For the PPE required to protect against risks associated with the workplace, installation or operating conditions, please refer to:</p> <ul style="list-style-type: none"> • the regulations in force in the country of installation; • <u>any information provided by the Safety Manager at the installation facility.</u>
Equipment required	Refer to chapter 7 "Equipment for commissioning/maintenance".

Tab. 10.59.

10.3 - TROUBLESHOOTING

NOTICE!

**Repair of defective meters is preferably carried out at the PIETRO FIORENTINI S.p.A. production plant
A new calibration will be carried out after the repair.**

During operation:

- irregular rotation or blocking of the totalising unit may indicate mechanical damage;
- excessive noise or vibration may indicate damage to bearings, turbine rotors or internal gear wheels.

If the problem is limited to the totaliser unit, this can also be replaced without depressurising the system.

If a low-frequency pulse output does not seem to work or does not provide an indication consistent with the indicator, the pulse generator can be replaced without removing the totaliser unit.

NOTICE!

For the pulse generator or totaliser unit replacement procedure, contact PIETRO FIORENTINI S.p.A.

NOTICE!

Depending on the regulations of the country where the meter is installed, removing the seals may result in the meter being recalibrated.

For correct troubleshooting, it is necessary to proceed by first consulting the troubleshooting tables in section 10.4.

10.4 - TROUBLESHOOTING TABLES



See Chapter 4 'Description and Operation' for pictures of the meter iM-TM and its accessories.

Failure	Possible causes	Intervention
Meter does not register the flow rate	Clogged line or meter.	Check the pipes and valves to make sure the gas can flow freely.
Low recorded flow rate	Oversized meter.	Check the meter size and flow rate.
	Friction within the meter.	Repair the meter (see Chapter 9 'Maintenance and Functional Checks').
High recorded flow rate	Deposits on turbine wheel	Clean/wash the wheel.
	Pulsating range.	Reduce pulsations.
	Intermittent flow rate.	Change the meter type.
High pressure drops	Friction within the meter.	Clean the meter.
	Worn bearings or wheels.	Repair the meter.
	Contaminated oil.	Replace the oil.
Vibrations	Misaligned pipes or tension.	Eliminate misalignments or tension.
	Contamination inside the meter.	See Chapter 9 'Maintenance and Functional Checks'.

Tab. 10.60.

PAGE INTENTIONALLY LEFT BLANK

11 - UNINSTALLATION AND DISPOSAL

11.1 - GENERAL SAFETY WARNINGS

HAZARD!



Make sure that there are no potentially explosive ignition sources in the work area set up to uninstall and/or dispose of the equipment.

WARNING!

Before proceeding with uninstallation and disposal, make the equipment safe by disconnecting it from any power supply.

11.2 - QUALIFICATION OF THE OPERATORS IN CHARGE

Uninstallation

Operator qualification	<ul style="list-style-type: none"> Installer.
PPE required	<div style="display: flex; align-items: center;">  </div> <div style="background-color: #f96; padding: 5px; margin-top: 5px;">  WARNING! </div> <p>The PPE listed in this table is related to the risk associated with the equipment. For the PPE required to protect against risks associated with the workplace, installation or operating conditions, please refer to:</p> <ul style="list-style-type: none"> the regulations in force in the country of installation; any information provided by the Safety Manager at the installation facility.
Equipment required	Refer to Chapter 7 'Commissioning/maintenance equipment'.

Tab. 11.61.

11.3 - UNINSTALLATION

ATTENTION!

Before uninstalling, discharge and completely drain the fluid in the line and inside the equipment.

To properly uninstall the equipment, proceed as specified in Tab. 11.62.:

Step	Action
1	Close the valves upstream and downstream of the equipment.
2	Depressurise the line then disconnect the upstream and downstream piping to the equipment by unscrewing the fittings with suitable hand tools.
3	Remove the equipment. <div style="border: 1px solid blue; padding: 5px; margin-top: 5px;">  NOTICE! </div> <p>Seal the valves upstream and downstream of the equipment if:</p> <ul style="list-style-type: none"> closing the system; the equipment is not replaced immediately.

Tab. 11.62.

11.4 - INFORMATION REQUIRED IN CASE OF RE-INSTALLATION

NOTICE!

Should the equipment be reused after uninstallation, refer to:

- Chapter 6 'Installation';
- Chapter 8 'Commissioning'.

11.5 - DISPOSAL INFORMATION

NOTICE!

- **Correct disposal avoids harm to man and the environment and allows valuable raw materials to be reused.**
- **The regulations in force in the country where the equipment is installed must be strictly observed.**
- **Unauthorised or incorrect disposal will result in the application of the sanctions provided for by the regulations in force in the country of installation.**

The equipment was manufactured with materials that can be recycled by specialised companies.
For proper disposal of the equipment, proceed as specified in Tab. 11.63:

Step	Action
1	Set up a large work area free from obstacles where to safely dismantle the equipment.
2	Sort the various components by type of material for easier recycling through separate collection.
3	Send the materials obtained in Step 2 to a specialised company.

Tab. 11.63.

11.5.1 - EQUIPMENT MATERIALS

The equipment in any configuration consists of the materials described in Tab.11.64.:

Material	Present in	Disposal/recycling indications
Aluminium alloy (anodised and non-anodised)	<ul style="list-style-type: none"> • Body • Impeller 	Disassemble and collect separately. Recycle through the appropriate centres.
Carbon steel	<ul style="list-style-type: none"> • Gears • Body 	Disassemble and collect separately. Recycle through the appropriate centres.
Stainless steel	<ul style="list-style-type: none"> • Bearings • Shafts • Hybrid connector 	Disassemble and collect separately. Recycle through the appropriate centres.
Synthetics/Technopolymer	Gears	Disassemble and collect separately. Recycle through the appropriate centres.
<ul style="list-style-type: none"> • Polycarbonate • Plastic material 	Totaliser unit	It must be collected and disposed of separately.
Lubricants/Oils	-	They must be collected and delivered to the appropriate specialised and authorised collection and disposal centres.
Pneumatic/electric components	-	They must be collected and delivered to the appropriate specialised and authorised collection and disposal centres.

Tab. 11.64.

NOTICE!

The above materials refer to standard versions. Different materials can be provided for specific needs.

PAGE INTENTIONALLY LEFT BLANK

12 - RECOMMENDED SPARE PARTS

12.1 - GENERAL WARNINGS

NOTICE!

If unmarked spare parts are used, PIETRO FIORENTINI S.p.A. their declared performance cannot be guaranteed.

It is recommended to use only original PIETRO FIORENTINI S.p.A. spare parts

PIETRO FIORENTINI S.p.A. shall not be held liable for any damage caused by using non-original parts.

12.2 - HOW TO REQUEST SPARE PARTS

NOTICE!

For specific information, please refer to the sales network of PIETRO FIORENTINI S.p.A.

12.3 - SPARE PARTS LIST

Reference to the spare parts order codes:

Code	Component
Contact PIETRO FIORENTINI S.p.A. with the meter serial number on the identification plate	Full totaliser
	Pulse emitter
Areoshell Fluid 12	Lubricating oil
TDO60261	100 ml bottle of oil
TDO60279	250 ml bottle of oil

Tab. 12.65.

TM0073ENG

